

□ AT-AR2010V

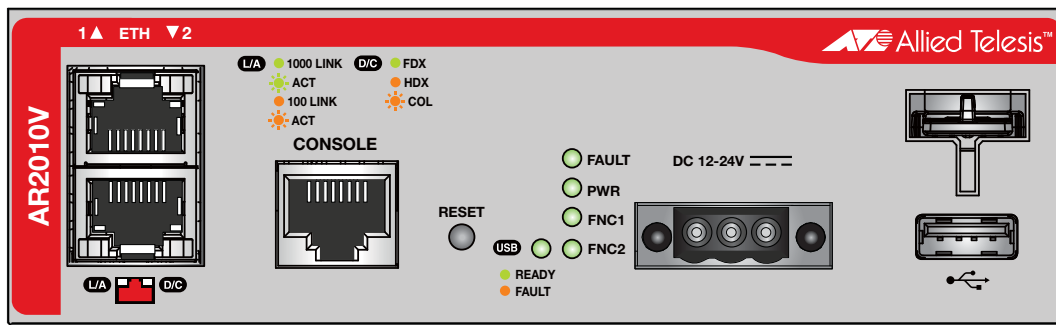

Installation Guide

Copyright © 2015 Allied Telesis, Inc.

All rights reserved. No part of this publication may be reproduced without prior written permission from Allied Telesis, Inc.

Allied Telesis and the Allied Telesis logo are trademarks of Allied Telesis, Incorporated. All other product names, company names, logos or other designations mentioned herein are trademarks or registered trademarks of their respective owners.

Allied Telesis, Inc. reserves the right to make changes in specifications and other information contained in this document without prior written notice. The information provided herein is subject to change without notice. In no event shall Allied Telesis, Inc. be liable for any incidental, special, indirect, or consequential damages whatsoever, including but not limited to lost profits, arising out of or related to this manual or the information contained herein, even if Allied Telesis, Inc. has been advised of, known, or should have known, the possibility of such damages.

Electrical Safety and Emissions Standards

This product meets the following standards.

U.S. Federal Communications Commission

Radiated Energy

Note: This equipment has been tested and found to comply with the limits for a Class A digital device pursuant to Part 15 of FCC Rules. These limits are designed to provide reasonable protection against harmful interference when the equipment is operated in a commercial environment. This equipment generates, uses, and can radiate radio frequency energy and, if not installed and used in accordance with this instruction manual, may cause harmful interference to radio communications. Operation of this equipment in a residential area is likely to cause harmful interference in which case the user will be required to correct the interference at his own expense.

Note: Modifications or changes not expressly approved of by the manufacturer or the FCC, can void your right to operate this equipment.

Industry Canada

This Class A digital apparatus complies with Canadian ICES-003.

Cet appareil numérique de la classe A est conforme à la norme NMB-003 du Canada.

Warning: In a domestic environment this product may cause radio interference in which case the user may be required to take adequate measures.

EMC: Not available at present

Electrical Safety: Not available at present

Environmental Compliance: Not available at present

Translated Safety Statements

Important: Safety statements that have the  symbol are translated into multiple languages in the *Translated Safety Statements* document at www.alliedtelesis.com/support.

Contents

- Preface** 11
 - Document Conventions 12
 - Contacting Allied Telesis 13
- Chapter 1: Overview** 15
 - Features 16
 - ETH Ports 16
 - USB Port 16
 - USB Retainer Slot 16
 - Reset Button 16
 - LEDs 16
 - DC Power Inlet 16
 - Kensington Lock Hole 17
 - Installation Options 17
 - Management Software and Interfaces 17
 - Management Methods 17
 - Package Contents 18
 - Front and Back Panels 19
 - Management Panel 20
 - Management Software 21
 - ETH Ports 22
 - LEDs 23
 - Power LED 23
 - Fault LED 24
 - USB LED 24
 - ETH1 Port LEDs 25
 - 26
 - ETH2 Port LEDs 27
 - Function 1 LED 28
 - Function 2 LED 28
 - USB Port 29
 - DC Power Inlet 30
 - USB Retainer Slot 31
 - Console Port 34
 - Reset Button 35
 - Power Supply 36
- Chapter 2: Beginning the Installation** 37
 - Reviewing Safety Precautions 38
 - Choosing a Site for the Routers 41
 - Unpacking the Router 42
- Chapter 3: Installing the Router and Powering on the Router** 43
 - Installing the Router on a Table or Desktop 44
- Chapter 4: Cabling the Networking Ports** 53
 - Cabling the Twisted Pair Ports 54
- Chapter 5: Troubleshooting** 57
- Appendix A: Technical Specifications** 59

Contents

Physical Specifications	59
Environmental Specifications.....	59
Power Specifications	61
Certifications	61
RJ-45 Twisted Pair Port Pinouts.....	62
RJ-45 Style Serial Console Port Pinouts	63
Front DC Power Connector	63

Figures

Figure 1: Front panel of the AT-AR2010V router.....	19
Figure 2: Back panel of the AT-AR2010V router	19
Figure 3: AT-AR2010V management panel.....	20
Figure 4: ETH ports	22
Figure 5: Power LED	23
Figure 6: Fault LED.....	24
Figure 7: USB LED	25
Figure 8: ETH1 Port LEDs.....	25
Figure 9: ETH2 Port LEDs.....	27
Figure 10: Function 1 LED.....	28
Figure 11: Function 2 LED.....	28
Figure 12: USB port.....	29
Figure 13: DC Power Inlet	30
Figure 14: USB retainer slot	31
Figure 15: USB retainer	32
Figure 16: Attaching the USB retainer.....	32
Figure 17: Attaching the cable tie	33
Figure 18: Console port	34
Figure 19: Reset button	35
Figure 20: Components of the AT-AR2010V router.....	42
Figure 21: Attaching the rubber feet	45
Figure 22: Orienting the mounting kit.....	47
Figure 23: Securing the mounting kit.....	47
Figure 24: Rotating the router down to snap it into place	48
Figure 25: Connecting the Management Cable to the Console Port	50
Figure 26: Router initialization messages.....	51
Figure 27: Router initialization messages (Continued).....	52
Figure 28: RJ-45 Socket Pin Layout (Front View)	62
Figure 29: Front DC Power Connector	63

Tables

Table 1: Power LED	23
Table 2: Fault LED	24
Table 3: USB LED	25
Table 4: LEDs for ETH1 Port	26
Table 5: LEDs for ETH2 Port	27
Table 6: Product Dimension	59
Table 7: Product Weight	59
Table 8: Environmental Specifications	59
Table 9: Maximum Power Consumption	61
Table 10: Input Voltages	61
Table 11: Product Certifications	61
Table 12: Pin Signals for 10 and 100 Mbps	62
Table 13: Pin Signals for 1000 Mbps	62
Table 14: RJ-45 Style Serial Console Port Pin Signals	63
Table 15: Front DC Power Connector Pin Signals	64

Preface

This guide contains the installation instructions for the AT-AR2010V router.
This preface contains the following sections:

- “Document Conventions” on page 12
- “Contacting Allied Telesis” on page 13

Document Conventions

This document uses the following conventions:

Note

Notes provide additional information.



Caution

Cautions inform you that performing or omitting a specific action may result in equipment damage or loss of data.



Warning

Warnings inform you that performing or omitting a specific action may result in bodily injury.

Contacting Allied Telesis

If you need assistance with this product, you may contact Allied Telesis technical support by going to the Support & Services section of the Allied Telesis web site at **www.alliedtelesis.com/support**. You can find links for the following services on this page:

- ❑ 24/7 Online Support — Enter our interactive support center to search for answers to your product questions in our knowledge database, to check support tickets, to learn about RMAs, and to contact Allied Telesis technical experts.
- ❑ USA and EMEA phone support — Select the phone number that best fits your location and customer type.
- ❑ Hardware warranty information — Learn about Allied Telesis warranties and register your product online.
- ❑ Replacement Services — Submit a Return Merchandise Authorization (RMA) request via our interactive support center.
- ❑ Documentation — View the most recent installation and user guides, software release notes, white papers, and data sheets for your products.
- ❑ Software Downloads — Download the latest software releases for your managed products.

For sales or corporate information, go to **www.alliedtelesis.com/purchase** and select your region.

Chapter 1

Overview

This chapter contains the following sections:

- ❑ “Features” on page 16
- ❑ “Package Contents” on page 18
- ❑ “Front and Back Panels” on page 19
- ❑ “Management Panel” on page 20
- ❑ “Management Software” on page 21
- ❑ “ETH Ports” on page 16
- ❑ “LEDs” on page 23
- ❑ “USB Port” on page 29
- ❑ “DC Power Inlet” on page 30
- ❑ “USB Retainer Slot” on page 31
- ❑ “Console Port” on page 34
- ❑ “Reset Button” on page 35
- ❑ “Power Supply” on page 36

Features

Here are the features of the AT-AR2010V router.

ETH Ports

Here are the basic features of the ETH ports.

- Two copper ETH ports for WAN connection
- 10Base-T (IEEE 802.3i), 100Base-TX (IEEE 802.3u), and 1000Base-T (IEEE 802.3ab) compliant
- IEEE 802.3u Auto-Negotiation compliant
- Auto-MDI/MDIX
- 100 meters (328 feet) maximum operating distance
- RJ-45 connectors

USB Port

Here is the basic feature of the USB port.

- Used for maintenance

USB Retainer Slot

Here are the basic features of the USB retainer slot.

- Used in conjunction with the USB retainer kit
- Used for preventing the USB device from falling out of the router

Reset Button

Here are the basic features of the reset button.

- Returns to factory default settings
- Reboots the router

LEDs

Here are the LEDs.

- One Power LED
- One Fault LED
- One USB LED
- One Duplex/collision LED and one link/activity LED for the ETH 1 port
- One Duplex/collision LED and one link/activity LED for the ETH 2 port
- One Function 1 LED
- One Function 2 LED

DC Power Inlet

Here are the basic features of the DC power inlet.

- One DC power inlet on the front panel

- Supports external DC power supply
- One AC Adapter connector on the back panel for external AC power supply

Kensington Lock Hole

Here are the basic features of the Kensington lock hole.

- Used for attaching a lock-and-cable apparatus
- One hole located on the center of the back panel

Installation Options

Here are the installation options for the routers.

- Desk or tabletop
- DIN rail mounting

Management Software and Interfaces

Here are the management software and interfaces.

- AlliedWare Plus™ Operating System
- Command line interface

Management Methods

Here are the methods for managing the routers.

- Local management through the Console port
- Remote Telnet and Secure Shell management
- SNMPv1, v2c, and v3

Package Contents

- ❑ 1 main unit
- ❑ 1 AC Adapter and regional power cord
- ❑ 1 addendum document sheet
- ❑ 1 USB retainer
- ❑ 1 double-side adhesive tape
- ❑ 2 cable ties
- ❑ 4 stick-on rubber feet kit
- ❑ 1 RS-232 console cable
- ❑ 1 3-Pin DC plug to go with the DC input socket on the front panel

Front and Back Panels

The front panel of the AT-AR2010V router is shown in Figure 1.

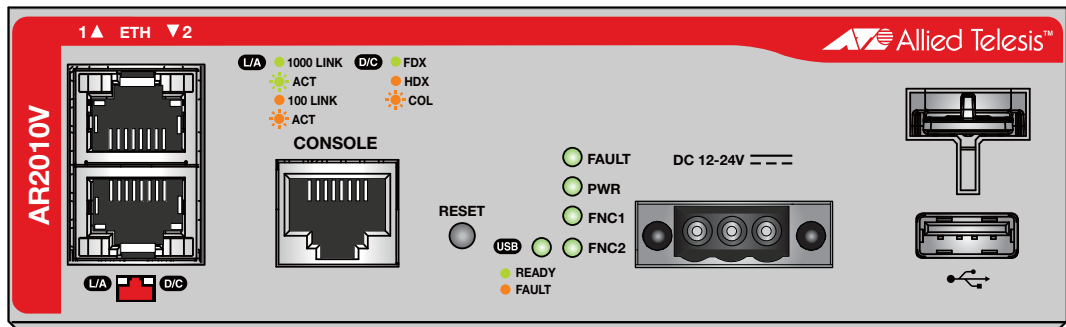

Figure 1. Front panel of the AT-AR2010V router

The back panel of the AT-AR2010V router is shown in Figure 2.

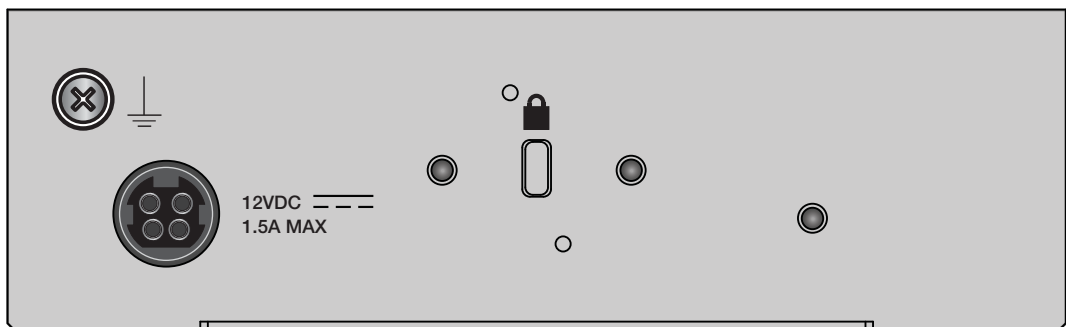

Figure 2. Back panel of the AT-AR2010V router

Management Panel

Figure 3 identifies the components in the management panel on the AT-AR2010V router.

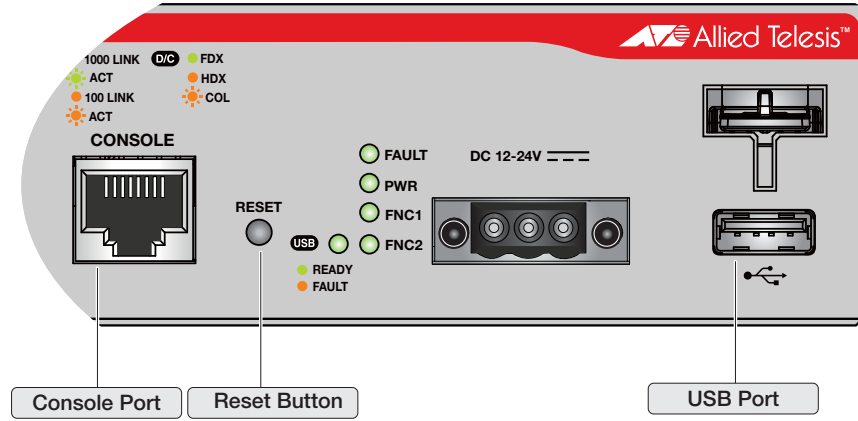

Figure 3. AT-AR2010V management panel

Management Software

The routers are shipped with the management software pre-installed. The software provides a Command Line Interface (CLI) management.

In the unlikely event that the management software becomes corrupted or damaged on the router, you can download the software from the Allied Telesis corporate web site and reinstall it on the router. For instructions on how to install new management software, see the production documentation.

ETH Ports

The AT-AR2010V router features two ETH ports for WAN connection. All ports support 10/100/1000 Mbps twisted pair ports and are 10Base-T, 100Base-TX, and 1000Base-T compliant. You can set the port speeds and duplex modes either automatically with IEEE 802.3u Auto-Negotiation or manually with the management software.

The twisted pair ports feature 8-pin RJ-45 connectors. For the port pinouts, see “RJ-45 Twisted Pair Port Pinouts” on page 62.

The ports have a maximum operating distance of 100 m (328 feet). For 10 Mbps operation, the ports require Category 3 or better 100 ohm shielded or unshielded twisted pair cabling. For 100 or 1000 Mbps operation, the ports require Category 5 or Enhanced Category 5 (5e) 100 ohm shielded or unshielded twisted pair cabling.

Note

A router port connected to an end node that is not using Auto-Negotiation should not use Auto-Negotiation to set the speed and duplex mode, because a duplex-mode mismatch may occur. In this case, disable Auto-Negotiation and set the port’s speed and duplex mode manually.

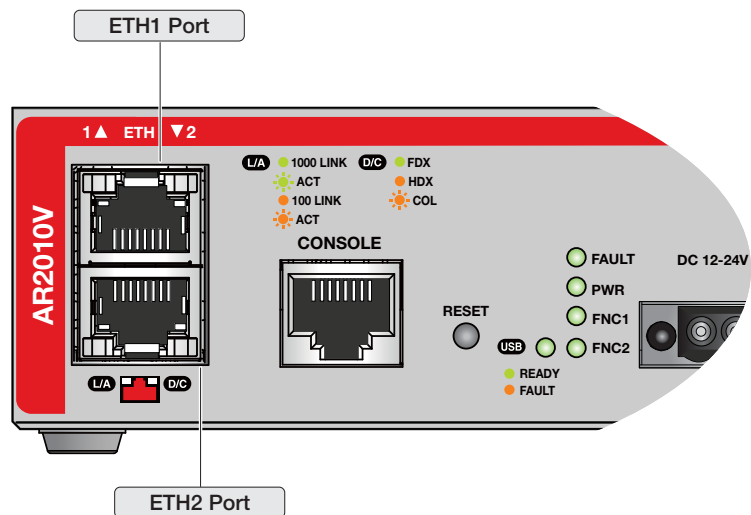

Figure 4. ETH ports

LEDs

Here are the descriptions of the LEDs.

Power LED The Power LED reports the status of DC power. The LED is shown in Figure 5.

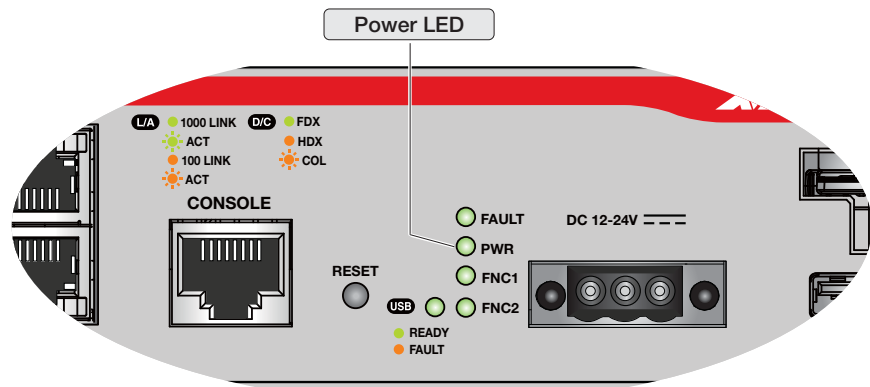

Figure 5. Power LED

The LED is described in Table 1.

Table 1. Power LED

LED	State	Description
Power	Off	The router is not receiving DC power or the internal PSU is not functioning.
	Steady Green	The router is receiving DC input power.

Fault LED The Fault LED reports the status of the router. The LED is shown in Figure 6.

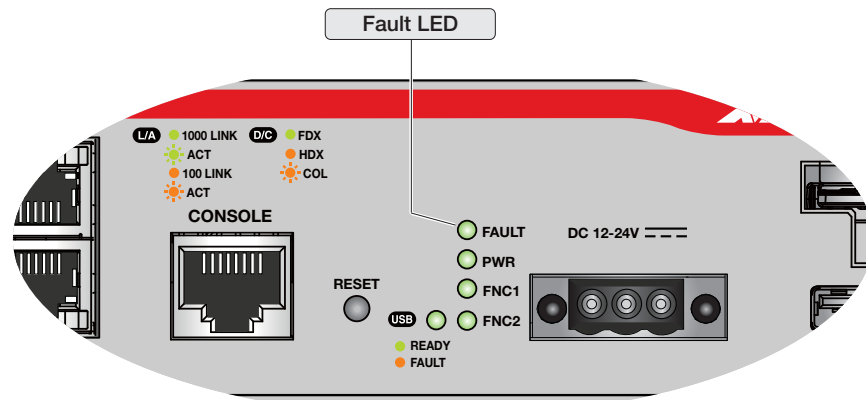

Figure 6. Fault LED

The LED is described in Table 2.

Table 2. Fault LED

LED	State	Description
Fault	Off	The router is operating normally.
	2 Red Flashes	Indicate a power (internal voltage) fault.
	6 Red Flashes	Indicates a temperature fault.
	Steady Red	The router is unable to boot.

USB LED The USB LED reports the status of the USB memory device. The LED is shown in Figure 7.

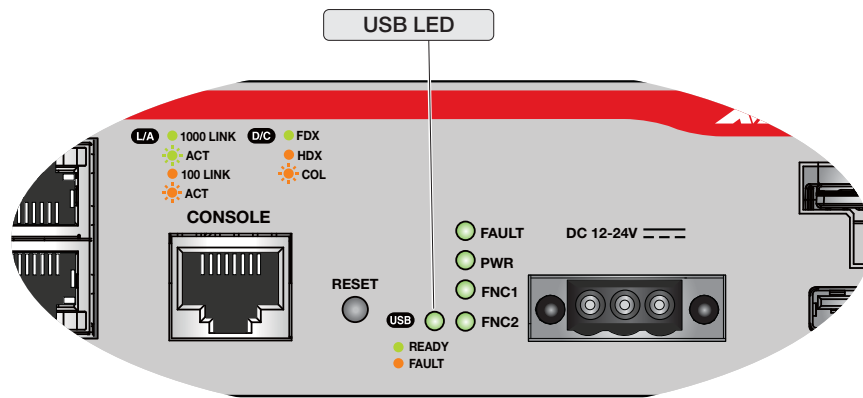

Figure 7. USB LED

The LED is described in Table 3.

Table 3. USB LED

LED	State	Description
USB	Off	No USB memory device is attached.
	Steady Yellow	USB memory device is experiencing failure.
	Steady Green	USB memory device is mounted correctly.

ETH1 Port LEDs

The ETH1 port has two LEDs that display link, activity, duplex and collision information. The LEDs are shown in Figure 8.

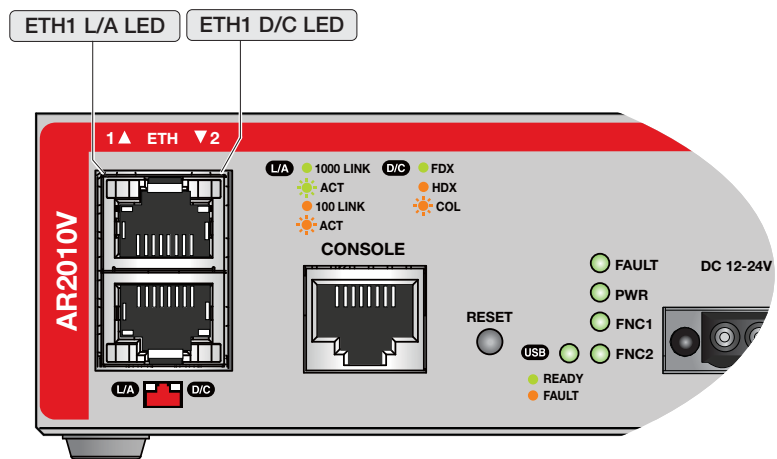

Figure 8. ETH1 Port LEDs

The LEDs are described in Table 4.

Table 4. LEDs for ETH1 Port

LED	State	Description
Link/ Activity LED	Solid Green	A port has established a 1000 Mbps link to a network device.
	Blinking Green	A port is transmitting or receiving data at 1000 Mbps.
	Solid Yellow	A port has established a 10 Mbps or 100 Mbps link to a network device.
	Blinking Yellow	A port is transmitting or receiving data at 10 or 100 Mbps.
	Off	A port has not established a link with another network device.
Duplex Mode LED	Solid Green	A port is operating in full duplex mode.
	Solid Yellow	A port is operating in half-duplex mode at 10 or 100 Mbps. (Half-duplex mode does not apply to 1000 Mbps operation.)
	Blinking Yellow	Collisions are occurring on a port operating at 10 or 100 Mbps.
	Off	A port has not established a link with another network device.

ETH2 Port LEDs

The ETH2 port has two LEDs that display link, activity, duplex and collision information. The LEDs are shown in Figure 9.

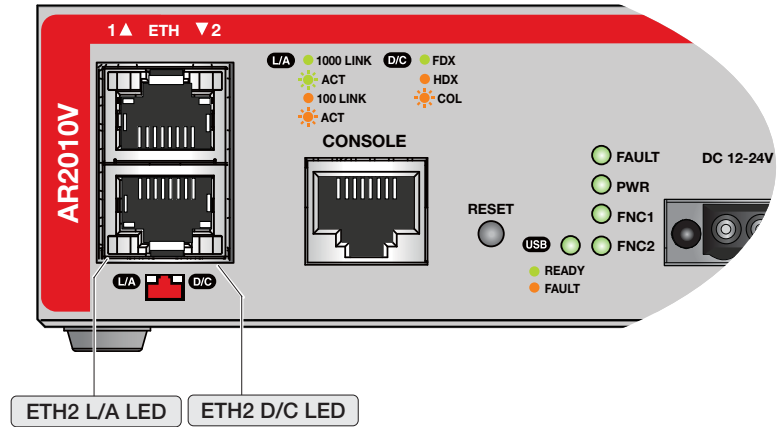

Figure 9. ETH2 Port LEDs

The LEDs are described in Table 4.

Table 5. LEDs for ETH2 Port

LED	State	Description
Link/ Activity LED	Solid Green	A port has established a 1000 Mbps link to a network device.
	Blinking Green	A port is transmitting or receiving data at 1000 Mbps.
	Solid Yellow	A port has established a 10 Mbps or 100 Mbps link to a network device.
	Blinking Yellow	A port is transmitting or receiving data at 10 or 100 Mbps.
	Off	A port has not established a link with another network device.
Duplex Mode LED	Solid Green	A port is operating in full duplex mode.
	Solid Yellow	A port is operating in half-duplex mode at 10 or 100 Mbps. (Half-duplex mode does not apply to 1000 Mbps operation.)
	Blinking Yellow	Collisions are occurring on a port operating at 10 or 100 Mbps.

LED	State	Description
	Off	A port has not established a link with another network device.

Function 1 LED

The Function 1 LED is shown in Figure 10. The Function 1 LED is user configurable and controlled by trigger actions.

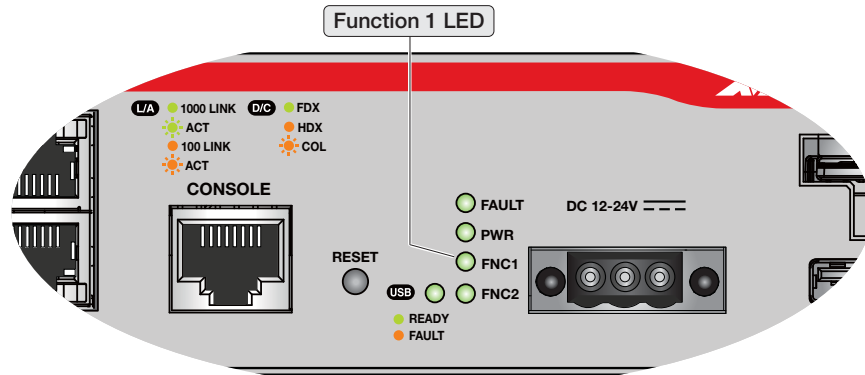

Figure 10. Function 1 LED

Function 2 LED

The Function 2 LED is shown in Figure 11. The Function 2 LED is user configurable and controlled by trigger actions.

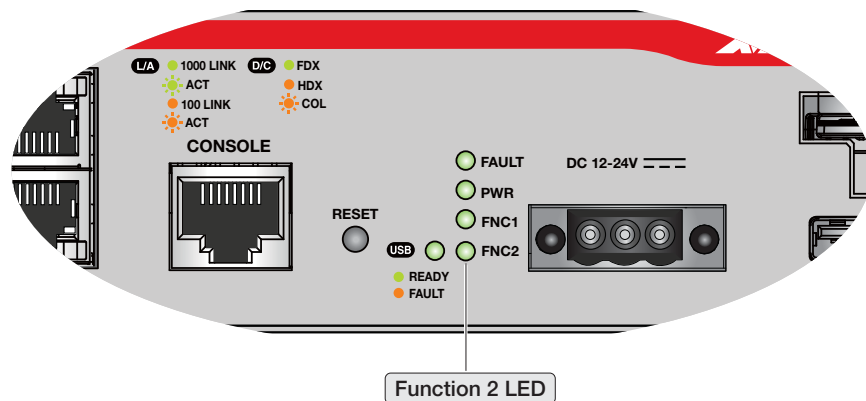

Figure 11. Function 2 LED

USB Port

The management panel has a USB port which is shown in Figure 12. You may also use the port for the following maintenance purposes.

- ❑ Store configuration files on a USB device and copy the files to routers whose settings have been lost or corrupted
- ❑ Update the management firmware on the routers

The USB port is USB2.0 type-A compatible.

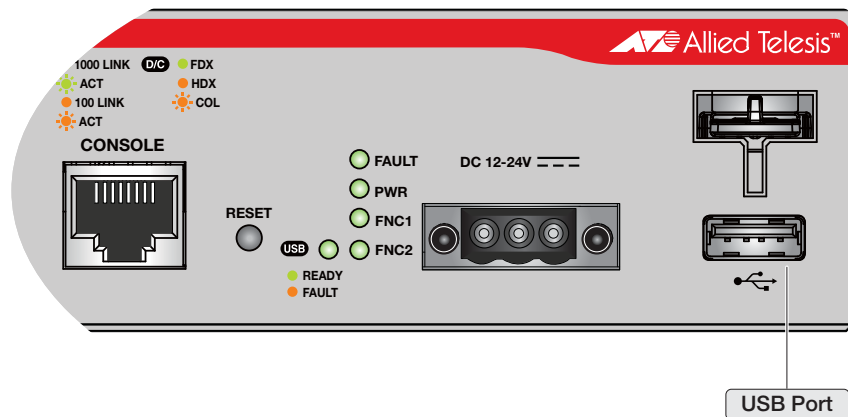

Figure 12. USB port

DC Power Inlet

The router has a DC power inlet which is shown in Figure 13. A single 3-pin power connector is available for DC power input. The front panel power socket is used when the router is mounted in a DIN rail, or powered from a building with a centralized 12-24V DC feed.

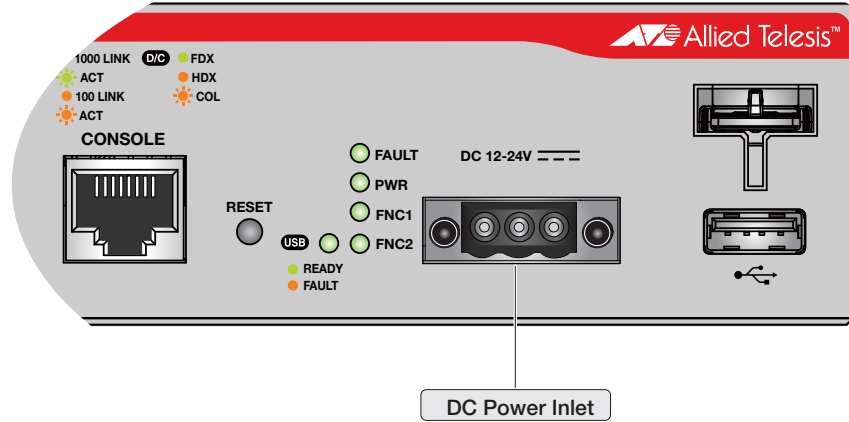

Figure 13. DC Power Inlet

USB Retainer Slot

The management panel has a USB retainer slot which is shown in Figure 14. You can use the USB retainer kit and the USB retainer slot to prevent the USB device from falling out of the USB port.

Note

Cable ties are designed to be used only once. Before you tighten them make sure they are positioned where you want them.

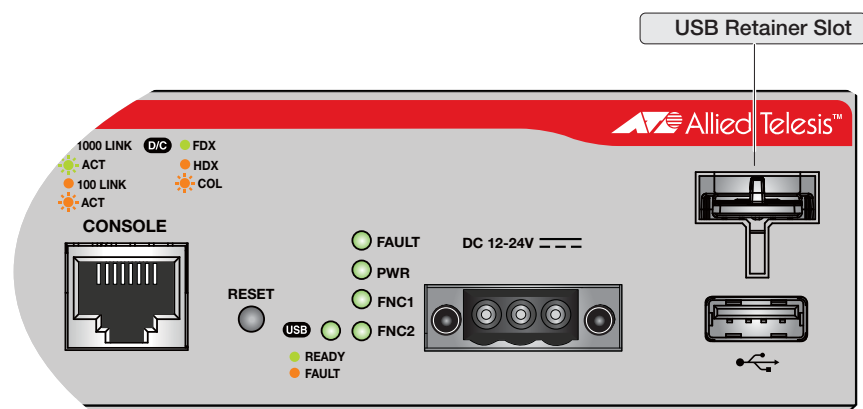

Figure 14. USB retainer slot

The following steps describe how to use the USB retainer kit and the USB retainer slot.

1. To fit the shape of the USB device, cut the USB retainer to an appropriate size and stick the double-side adhesive tape onto the back of the USB retainer as shown in Figure 15.

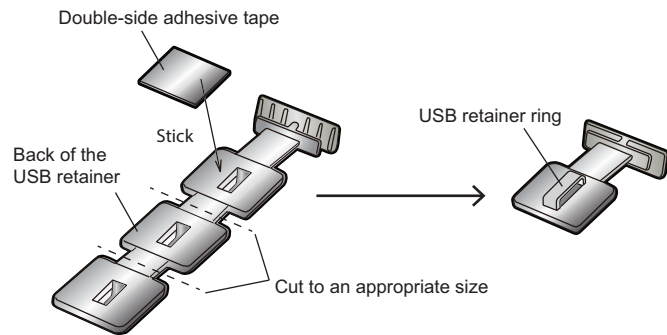

Figure 15. USB retainer

2. Mount the USB device into the USB port and then attach the H-shaped tip of the USB retainer to the USB retainer slot as shown in Figure 16.

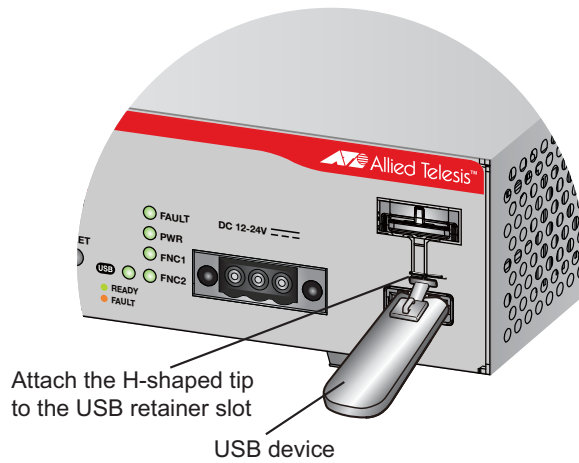

Figure 16. Attaching the USB retainer

3. Stick the double-side adhesive tape onto the back of the USB retainer. Wrap the cable tie around the USB device and pass the flat side through the USB retainer ring. Move the arm into position and the buckle of the cable tie under the device and tighten the tie.

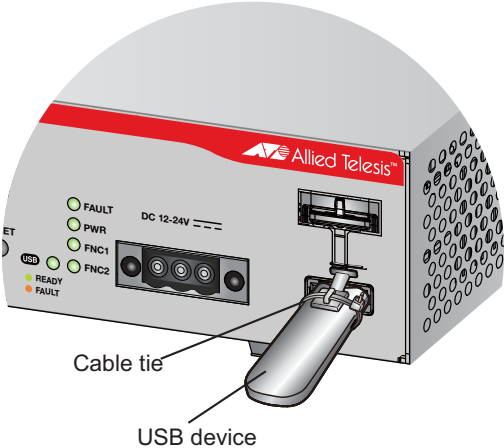

Figure 17. Attaching the cable tie

Console Port

The Console port is used to establish a management session with the router to configure its features and parameter settings. The Console port is shown in Figure 18. This type of management uses serial RS-232 and is commonly referred to as local or out-of-band management because it is not conducted over your network. To perform local management, you must be at the location of the router and must use the management cable included with the router.

To establish a local management session with the router, connect a terminal or a personal computer with a terminal emulation program to the Console port, which has an RJ-45 style (8P8C) connector, using the provided management cable. The cable has RJ-45 style (8P8C) and DB-9 (D-sub 9-pin female) connectors.

The Console port is set to the following specifications.

- Default baud rate: 9600 bps
- Supported baud rate: 9600 bps, 14400 bps, 19200 bps, 28800 bps, 38400 bps, 57600 bps, 115200 bps
- Data bits: 8
- Parity: None
- Stop bits: 1
- Flow control: None

Note

These settings are for a DEC VT100 or ANSI terminal, or an equivalent terminal emulation program.

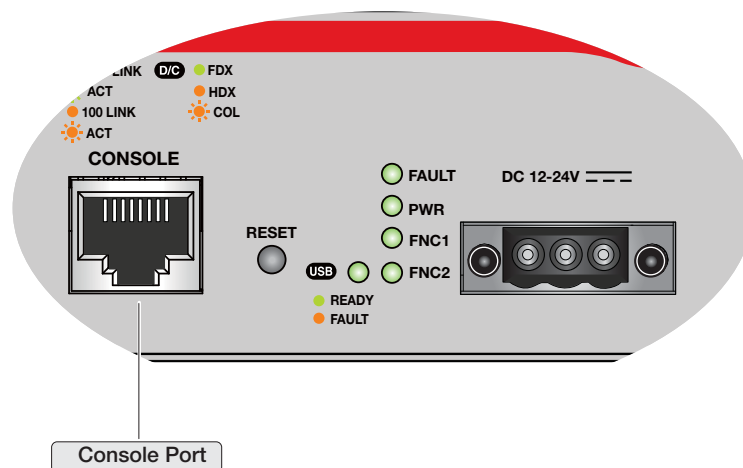

Figure 18. Console port

Reset Button

The reset button is located between the Console port and the USB port. You may use the reset button to restore the router to its factory default settings or reboot the router.

- ❑ To return to the factory default settings, press and hold the reset button for at least 5 seconds, and then release the button.
- ❑ To return to the normal configuration and reboot the router, press and hold the reset button for at least 1 second but less than 5 seconds, and then release the button.

Note

You won't lose files that contain user information by rebooting the router.

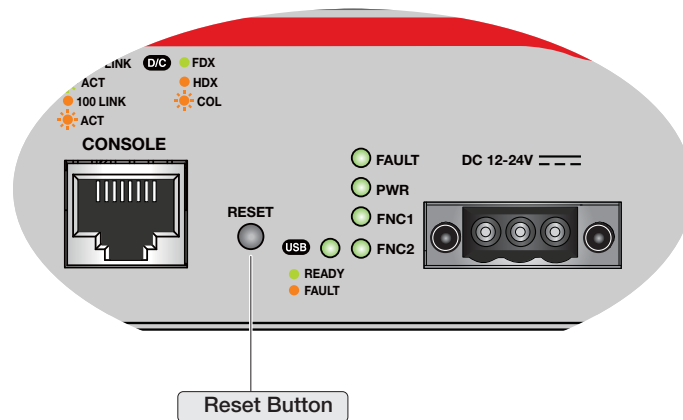

Figure 19. Reset button

Power Supply

A single 4-pin latching type connector is available on the back panel for power supply. The connector accepts 12V DC power supply. The connector is not accessible when DIN rail mounting kit is used. The rear power socket is only used when the router is sitting horizontally on a desk or table. You can use the power cable and AC power Adapter which are supplied with the router to power the router from AC mains.

The router also has a DC power inlet on the front panel. A single 3-pin power connector is available for DC power input. The front panel power socket is used when the router is mounted in a DIN rail, or powered from a building with a centralized 12-24V DC feed.

Refer to “Technical Specifications” on page 59 for the input voltage range.



Warning

Power cord is used as a disconnection device. To de-energize equipment, disconnect the power cord. *ES* E3

Chapter 2

Beginning the Installation

The chapter contains the following sections:

- “Reviewing Safety Precautions” on page 38
- “Choosing a Site for the Routers” on page 41
- “Unpacking the Router” on page 42

Reviewing Safety Precautions

Review the following safety precautions before beginning the installation procedure.

Note

Safety statements that have the  symbol are translated into multiple languages in the *Translated Safety Statements* document at www.alliedtelesis.com/support.



Warning

Do not work on equipment or cables during periods of lightning activity.  E2



Warning

Power cord is used as a disconnection device. To de-energize equipment, disconnect the power cord.  E3

Note

Pluggable Equipment. The socket outlet shall be installed near the equipment and shall be easily accessible.  E5



Warning

Operating Temperatures. The router is designed for a maximum ambient temperature of 50° degrees C.



Warning

Hot Surface
Do not touch

Note

All Countries: Install product in accordance with local and National Electrical Codes.  E8



Warning

Only trained and qualified personnel are allowed to install or replace this equipment. ⚡ E14



Caution

Circuit Overloading: Consideration should be given to the connection of the equipment to the supply circuit and the effect that overloading of circuits might have on overcurrent protection and supply wiring. Appropriate consideration of equipment nameplate ratings should be used when addressing this concern. ⚡ E21



Caution

Risk of explosion if battery is replaced by an incorrect type. Replace only with the same or equivalent type recommended by the manufacturer. Dispose of used batteries according to the manufacturer's instructions.

Attention: Le remplacement de la batterie par une batterie de type incorrect peut provoquer un danger d'explosion. La remplacer uniquement par une batterie du même type ou de type équivalent recommandée par le constructeur. Les batteries doivent être éliminées conformément aux instructions du constructeur. ⚡ E22

Note

Use dedicated power circuits or power conditioners to supply reliable electrical power to the device. ⚡ E27



Caution

The unit does not contain serviceable components. Please return damaged units for servicing. ⚡ E42

Choosing a Site for the Routers

Observe these requirements when planning the installation of the router.

- If you plan to install the routers on a table, check to be sure that the table is level and stable.
- The power outlet should be located near the routers and be easily accessible.
- The site should allow for easy access to the ports on the front of the routers, so that you can easily connect and disconnect cables, and view the port LEDs.
- The site should not expose the routers to moisture or water.
- The site should be a dust-free environment.
- The site should include dedicated power circuits or power conditioners to supply reliable electrical power to the network devices.
- Do not install the routers in a wiring or utility box because it will overheat and fail from inadequate airflow.



Warning

Routers should not be stacked on top of one another on a table or desktop because that could present a personal safety hazard if you need to move or replace routers.

Unpacking the Router

Figure 20 lists the items that come with the AT-AR2010V router. If any item is missing or damaged, contact your Allied Telesis sales representative for assistance. You should retain the original packaging material in the event you need to return the unit to Allied Telesis.

cord



One 2 m (6.6 ft) local management cable with RJ-45 (8P8C) and DB-9 (D-sub 9-pin female) connectors.

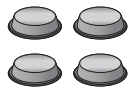

Four rubber feet



One AC Adapter and power cord

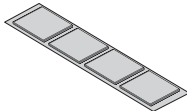

One double-side adhesive tape

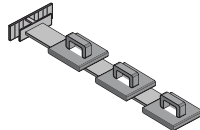

One USB retainer

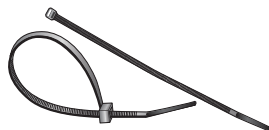

Two cable ties



One 3-Pin DC plug to go with the DC input socket on the front panel



One addendum document sheet

Figure 20. Components of the AT-AR2010V router

Chapter 3

Installing the Router and Powering on the Router

The procedures in this chapter are:

- ❑ “Installing the Router on a Table or Desktop” on page 44
- ❑ “Fitting Rubber Feet” on page 45
- ❑ “Installing the Router in a DIN Rail” on page 46
- ❑ “Connecting DC Power to a Power Supply Module” on page 49
- ❑ “Starting a Local Management Session” on page 50
- ❑ “Monitoring the Initialization Processes” on page 51

Installing the Router on a Table or Desktop

You may install the routers on a table or desktop. Here are the guidelines to selecting a site.

- The table should be level and stable.
- The power outlet should be located near the routers and be easily accessible.
- The site should allow for easy access to the ports on the front of the routers, so that you can easily connect and disconnect cables, and view the port LEDs.
- The site should not expose the routers to moisture or water.
- The site should be a dust-free environment.
- The site should include dedicated power circuits or power conditioners to supply reliable electrical power to the network devices.
- The rubber feet on the bottom of the routers should be fitted for table or desktop installation.



Warning

Do not stack routers on top of one another on a table or desktop because that could present a personal safety hazard if you need to move or replace routers.

After placing the router on the table or desktop, go to Chapter 4, “Cabling the Networking Ports” on page 53 to connect the network cables to the ports on the router.

Fitting Rubber Feet

If your routers do not already have rubber feet fitted, fit these as follows:

1. Remove all equipment from the package and store the packaging material in a safe place.
2. Turn the router over and place it on a table.
3. Remove the adhesive rubber feet from the packaging and press them firmly onto the base of the router, as shown in Figure 21.

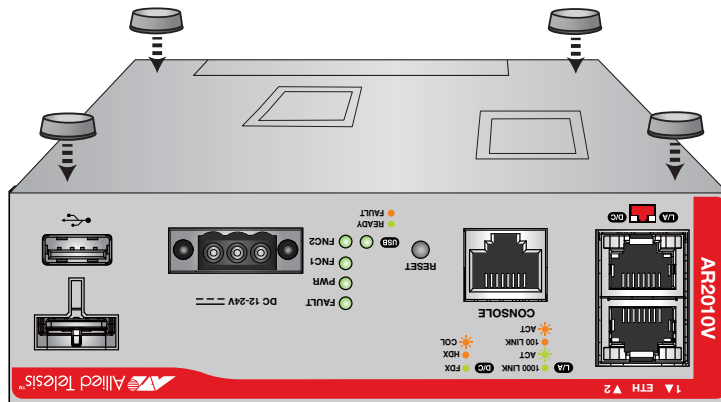

Figure 21. Attaching the rubber feet

4. Turn the router over again and place it on a flat, secure surface (such as a desk or table) leaving ample space around the unit for ventilation.

Installing the Router in a DIN Rail

Observe the following requirements when choosing a DIN rail site for your router:

- ❑ The site should allow for easy access to the ports on the front of the router, so that you can easily connect and disconnect cables, and view the port LEDs.
- ❑ The site should allow for adequate air flow around the unit and through the cooling fins.
- ❑ The site should not expose the router to moisture or water.
- ❑ The site should be a dust-free environment.
- ❑ The site should include dedicated power circuits or power conditioners to supply reliable electrical power to the network devices.

Note

The AC Adapter connector on the back panel of the router is not accessible when the DIN rail mounting kit is used.

Note

DIN rail mounting kits can be purchased separately from your Allied Telesis dealer.



Warning

Hot surface
Dot not touch

When the router is operating at vertical orientation, the base of the chassis can be hot.

Here is the procedure for installing the router in a DIN rail.

1. Orient the DIN rail mounting kit against the back panel of the router, and make sure that the holes align, as shown in Figure 22.

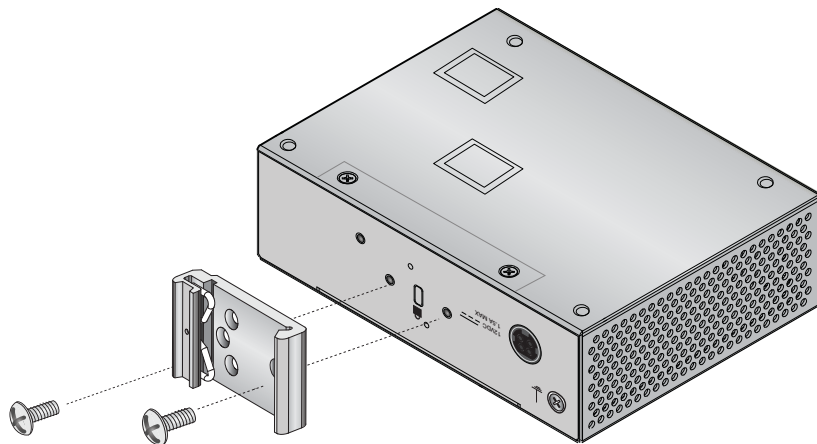

Figure 22. Orienting the mounting kit

2. Secure the mounting kit to the unit with the screws, as show in Figure 23.

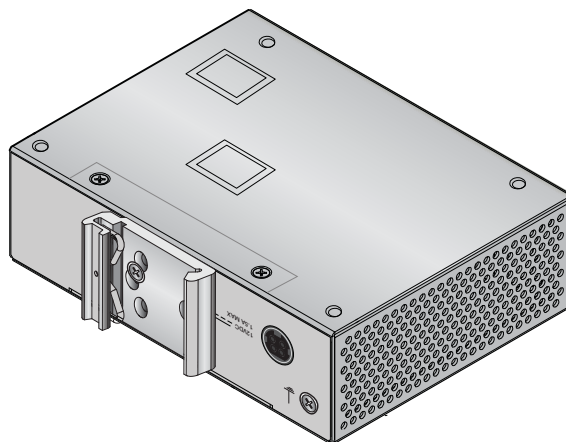

Figure 23. Securing the mounting kit

3. Rotate the router down to snap it into place.

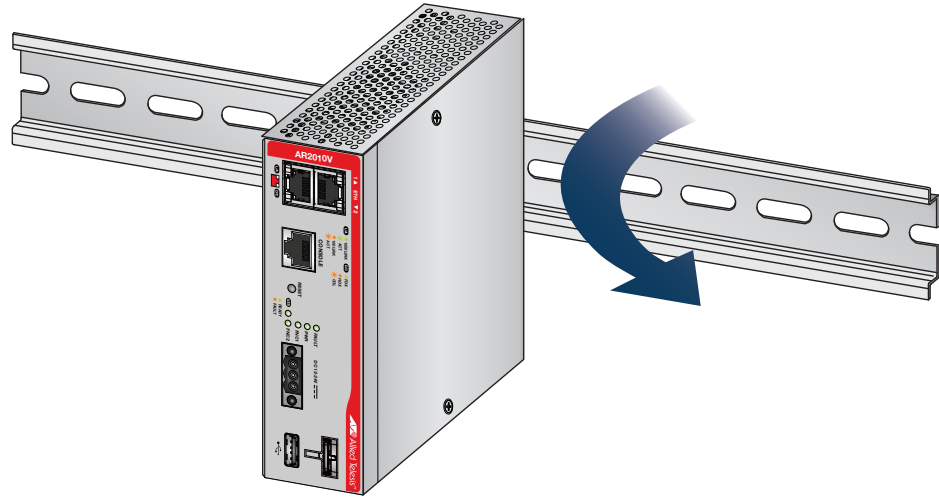

Figure 24. Rotating the router down to snap it into place

4. After snapping the router onto the DIN rail, go to Chapter 4, “Cabling the Networking Ports” on page 53, to connect the network cables to the ports on the router.

Connecting DC Power to a Power Supply Module



Warning

The router has two power connectors. Only one connector may be connected to a power source at a time.

To power on the router, perform the following procedure:

1. Join the AC Adapter and power cord and plug the AC Adapter into the connector on the back panel of the router.



Warning

The power cord is used as a disconnection device. To de-energize equipment, disconnect the power cord. ⚡ E3

Note

The connector is not accessible when DIN rail mounting kit is used. The rear power socket is only used when the router is sitting horizontally on a desk or table.

2. Connect the other end of the power cord to an appropriate AC power outlet. For power specifications for the router, refer to Appendix A, “Technical Specifications” on page 59.
3. Verify that the POWER LED is green.

Alternatively, you can power on the router by using the DC power inlet on the front panel.



Warning

For USA and Canada: The Front or Rear DC input power connector must be connected to a UL Listed power supply source, marked “LPS” or “Class 2”

1. Attach the 3-Pin DC plug to the DC power socket and make sure the two mounting screws are tightened to stop the plug from being pulled out.
2. Connect the other end of the DC plug to a building with a centralized 12-24V DC feed. For power specifications for the router, refer to Appendix A, “Technical Specifications” on page 59.
3. Verify that the POWER LED is green.

Starting a Local Management Session

This procedure requires a terminal or a terminal emulator program and the management cable that comes with the router. To start a local management session on the router, perform the following procedure:

1. Connect the RJ-45 connector on the management cable to the Console port on the front panel of the router, as shown in Figure 25.

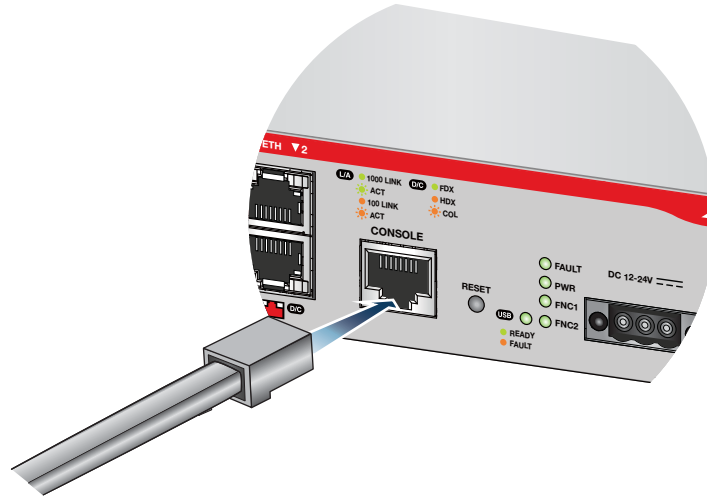

Figure 25. Connecting the Management Cable to the Console Port

2. Connect the other end of the cable to an RS-232 port on a terminal or PC with a terminal emulator program.
3. Configure the terminal or terminal emulator program as follows:
 - Baud rate: 9600 bps (9600 bps, 14400 bps, 19200 bps, 28800 bps, 38400 bps, 57600 bps, 115200 bps. The default is 9600 bps.)
 - Data bits: 8
 - Parity: None
 - Stop bits: 1
 - Flow control: None

Note

The port settings are for a DEC VT100 or ANSI terminal, or an equivalent terminal emulator program.

Monitoring the Initialization Processes

It takes about thirty seconds for the router to initialize its management software programs and features, and load the default configuration.

You may also monitor the bootup sequence by connecting a terminal or computer that has a terminal emulator program, to the console port on the router. You will see the messages from Figure 26 below to Figure 27 on page 52.

```

Starting base/first... [ OK ]
Mounting virtual filesystems... [ OK ]

      _____
     /          \
    /            \
   /              \
  /                \
 /                  \
/                    \
/_____ \
 \         /
  \       /
   \     /
    \   /
     \ /
      /

Allied Telesis Inc.
AlliedWare Plus (TM) v0.0.0
Current release filename: <release_file_name.rel>
Built: Wed Nov 4 02:32:10 UTC 2015
Mounting static filesystems... [ OK ]
Checking flash filesystem... [ OK ]
Mounting flash filesystem... [ OK ]
Checking for last gasp debug output... [ OK ]
Checking NVS filesystem... [ OK ]
Mounting NVS filesystem... [ OK ]
Starting base/dbus... [ OK ]
Starting base/syslog... [ OK ]
Starting base/loopback... [ OK ]
Starting base/sysctl... [ OK ]
Received event syslog.done
Starting base/reboot-stability... [ OK ]
Checking system reboot stability... [ OK ]
Starting base/cron... [ OK ]

```

Figure 26. Router initialization messages

```

Checking system reboot stability... [ OK ]
Starting base/cron... [ OK ]
Starting base/appmond... [ OK ]
Starting hardware/openhpi... [ OK ]
Starting hardware/timeout... [ OK ]
Starting base/inet... [ OK ]
Starting base/modules... [ OK ]
Received event modules.done
Received event board.inserted
Received event hardware.done
Starting network/startup... [ OK ]
Starting base/external-media... [ OK ]
Starting network/roboswitch... [ OK ]
Received event network.enabled

Initializing HA processes:
auth, hostd, hsl, irddp, lacp, loopprot, mstp
nsm, ospf6d, pimd, ripd, ripngd, rmon, tunneld
bgpd, cntrd, imi, ospfd

Received event network.initialized
Received event standalone

Assigning Active Workload to HA processes:
authd, hsl, imi, irddp, lacpd, loopprotd, mstpd
nsm, ripd, rmond

Received event network.activated

Loading default configuration
Warning: flash:/default.cfg does not exist, loading factory defaults.
..

done!
Received event network.configured

```

Figure 27. Router initialization messages (Continued)

Chapter 4

Cabling the Networking Ports

This chapter contains the following procedures:

- “Cabling the Twisted Pair Ports” on page 54

Cabling the Twisted Pair Ports

Here are the guidelines to cabling the 10/100/1000Base-T twisted pair ports.

- ❑ The connectors on the cables should fit snugly into the ports, and the tabs should lock the connectors into place.
- ❑ The default setting for the wiring configurations of the ports is auto-MDI/MDI-X. The default setting is appropriate for router ports that are connected to 10/100Base-TX network devices that also support auto-MDI/MDI-X.
- ❑ The default auto-MDI/MDI-X setting is not appropriate for router ports that are connected to 10/100Base-TX network devices that do not support auto-MDI/MDI-X and have a fixed wiring configuration. For router ports connected to those types of network devices, you should disable auto-MDI/MDI-X and set the wiring configurations manually.
- ❑ The appropriate MDI/MDI-X setting for a router port connected to a 10/100Base-TX network device with a fixed wiring configuration depends on the setting of the network device and whether the router and network device are connected with straight-through or crossover cable. If you are using straight-through twisted pair cable, the wiring configurations of a port on the router and a port on a network device must be opposite each other, such that one port uses MDI and the other MDI-X. For example, if a network device has a fixed wiring configuration of MDI, you must disable auto-MDI/MDI-X on the corresponding router port and manually set it to MDI-X. If you are using crossover twisted pair cable, the wiring configurations of a port on the router and a port on a network device must be the same.
- ❑ The default speed setting for the ports is Auto-Negotiation. This setting is appropriate for ports connected to network devices that also support Auto-Negotiation.
- ❑ The default speed setting of Auto-Negotiation is not appropriate for ports connected to 10/100Base-TX network devices that do not support Auto-Negotiation and have fixed speeds. For those router ports, you should disable Auto-Negotiation and set the port's speed manually to match the speeds of the network devices.
- ❑ The 10/100/1000Base-T ports must be set to Auto-Negotiation, the default setting, to operate at 1000Mbps.
- ❑ The default duplex mode setting for the ports is Auto-Negotiation. This setting is appropriate for ports connected to network devices that also support Auto-Negotiation for duplex modes.
- ❑ The default duplex mode setting of Auto-Negotiation is not appropriate for ports connected to network devices that do not

support Auto-Negotiation and have a fixed duplex mode. You should disable Auto-Negotiation on those ports and set their duplex modes manually to avoid the possibility of duplex mode mismatches. A router port using Auto-Negotiation defaults to half-duplex if it detects that the end node is not using Auto-Negotiation, which can result in a mismatch if the end node is operating at a fixed duplex mode of full-duplex.

Chapter 5

Troubleshooting

This chapter contains suggestions on how to troubleshoot the router if a problem occurs.

Note

For further assistance, please contact Allied Telesis Technical Support at www.alliedtelesis.com/support.

Problem 1: The POWER LED on the front of the router is off.

Solutions: The unit is not receiving power. Try the following:

- Verify that the power cord is securely connected to the power source and to the AC Adapter connector on the back panel of the router.
- Verify that the power outlet has power by connecting another device to it.
- Try connecting the unit to another power source.
- Try a different power cord.
- Verify that the voltage from the power source is within the required levels for your region.

Problem 2: A twisted pair port on the router is connected to a network device but the port's Link/Activity LED is off.

Solutions: The port is unable to establish a link to a network device. Try the following:

- Verify that the network device connected to the twisted pair port is powered on and is operating properly.
- Verify that the twisted pair cable is securely connected to the port on the media converter channel and to the port on the remote network device. Verify that the twisted pair cable is securely connected to the port on the media converter channel and to the port on the remote network device.
- Verify that the port is connected to the correct twisted pair cable. This is to eliminate the possibility that the port is connected to the wrong network device, such as a powered off device.
- Try connecting another network device to the twisted pair port with

a different cable. If the twisted pair port is able to establish a link, then the problem is with the cable or the other network device.

- ❑ Verify that the twisted pair cable does not exceed 100 meters (328 feet).
- ❑ Verify that you are using the appropriate category of twisted pair cable: Category 3 or better for 10 Mbps operation and Category 5 and Category 5e for 100 and 1000 Mbps operation.

Note

A 1000BASE connection may require five to ten seconds to establish a link.

Problem 3: Network performance between a twisted pair port on the router and a network device is slow.

Solutions: There might be a duplex mode mismatch between the port and the network device. This occurs when a twisted pair port using Auto-Negotiation is connected to a device with a fixed duplex mode of full duplex. If this is the cause of the problem, adjust the duplex mode of the port on the network device or on the router so that both ports are using the same duplex mode.

Problem 4: A port's Link/Activity LED is blinking.

Solutions: The link between the port and the network device is intermittent. Try the following:

- ❑ Connect another network device with a different cable to the port. If the Link LED remains steady on, then the problem is with the original cable or the network device.

Appendix A

Technical Specifications

Physical Specifications

Dimensions (Height x Width x Depth)

Table 6. Product Dimension

AT-AR2010V	42.5 mm x 140 mm x 105mm (1.7 in. x 5.5 in. x 4.1 in.)
------------	---

Weight

Table 7. Product Weight

AT-AR2010V	556 grams (1.2 lb.)
------------	---------------------

Environmental Specifications

Table 8. Environmental Specifications

Operating Temperature (horizontal fanless operation with AC or DC power)	0° C to 50° C (32° F to 122° F)
Operating Temperature (vertical fanless operation with AC or DC power)	0° C to 50° C (32° F to 122° F)
Storage Temperature	-20° C to 60° C (-4° F to 140° F)
Operating Humidity	5% to 80% noncondensing
Storage Humidity	5% to 95% noncondensing

Table 8. Environmental Specifications (Continued)

Maximum Operating Altitude	2,000 m (6,562 ft) You need to de-rate the operating temperature as altitude increases. A de-rating of 1° C for every 305 m (1,000 ft) normally applies.
Maximum Nonoperating Altitude	3,000 m (9,843 ft)

Power Specifications

Maximum Power Consumptions

Table 9. Maximum Power Consumption

DC Power Consumption	13 watts
AC Power Consumption	13 watts

Input Voltages

Table 10. Input Voltages

DC Power Consumption	12-24V, 1.5A maximum
AC Power Consumption	12VDC, 1.5A maximum

Certifications

Table 11. Product Certifications

EMC	Not available at present.
Electrical Safety	Not available at present.
Environmental Compliance	Not available at present.
CE Marking	Not available at present.

RJ-45 Twisted Pair Port Pinouts

Figure 28 illustrates the pin layout of the RJ-45 connectors and ports.

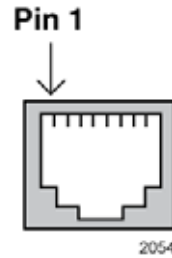

Figure 28. RJ-45 Socket Pin Layout (Front View)

Table 12 on page 62 lists the pin signals for 10 and 100 Mbps.

Table 12. Pin Signals for 10 and 100 Mbps

Pin	MDI Signal	MDI-X Signal
1	TX+	RX+
2	TX-	RX-
3	RX+	TX+
4	Not used	Not used
5	Not used	Not used
6	RX-	TX-
7	Not used	Not used
8	Not used	Not used

Table 13 lists the pin signals when a port operating at 1000 Mbps.

Table 13. Pin Signals for 1000 Mbps

Pinout	Pair
1	Pair 1 +
2	Pair 1 -
3	Pair 2 +
4	Pair 3 +

Table 13. Pin Signals for 1000 Mbps (Continued)

5	Pair 3 -
6	Pair 2 -
7	Pair 4 +
8	Pair 4 -

RJ-45 Style Serial Console Port Pinouts

Table 14 lists the pin signals of the RJ-45 style serial Console port.

Table 14. RJ-45 Style Serial Console Port Pin Signals

Pin	Signal
1	Looped to pin 8.
2	Looped to pin 7.
3	Transmit Data
4	Ground
5	Ground
6	Receive Data
7	Looped to pin 2.
8	Looped to pin 1.

Front DC Power Connector

Figure 29 illustrates the pin layout of the front DC power connector.

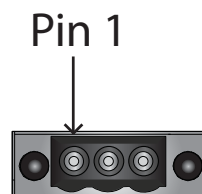

Figure 29. Front DC Power Connector

Table 14 lists the pin signals of the DC power connector on the front panel.

Table 15. Front DC Power Connector Pin Signals

Pin	Signal
1	GND
2	Negative
3	Positive 12-24V DC