

# Gigabit Ethernet WebSmart Switch

---

**AT-GS950/48**

## Installation Guide

copyright © 2010 Allied Telesis, Inc.

All rights reserved. No part of this publication may be reproduced without prior written permission from Allied Telesis, Inc.

Allied Telesis and the Allied Telesis logo are trademarks of Allied Telesis, Incorporated. All other product names, company names, logos or other designations mentioned herein are trademarks or registered trademarks of their respective owners.

Allied Telesis, Inc. reserves the right to make changes in specifications and other information contained in this document without prior written notice. The information provided herein is subject to change without notice. In no event shall Allied Telesis, Inc. be liable for any incidental, special, indirect, or consequential damages whatsoever, including but not limited to lost profits, arising out of or related to this manual or the information contained herein, even if Allied Telesis, Inc. has been advised of, known, or should have known, the possibility of such damages

# Electrical Safety and Emissions Standards

---

This product meets the following standards.

## U.S. Federal Communications Commission

### Radiated Energy

Note: This equipment has been tested and found to comply with the limits for a Class A digital device pursuant to Part 15 of FCC Rules. These limits are designed to provide reasonable protection against harmful interference when the equipment is operated in a commercial environment. This equipment generates, uses, and can radiate radio frequency energy and, if not installed and used in accordance with this instruction manual, may cause harmful interference to radio communications. Operation of this equipment in a residential area is likely to cause harmful interference in which case the user will be required to correct the interference at his own expense.

Note: Modifications or changes not expressly approved of by the manufacturer or the FCC, can void your right to operate this equipment.

## Industry Canada

This Class A digital apparatus complies with Canadian ICES-003.

Cet appareil numérique de la classe A est conforme à la norme NMB-003 du Canada.

## European Union Restriction of the Use of Certain Hazardous Substances (RoHS) in Electrical and Electronic Equipment

This Allied Telesis RoHS-compliant product conforms to the European Union Restriction of the Use of Certain Hazardous Substances (RoHS) in Electrical and Electronic Equipment. Allied Telesis ensures RoHS conformance by requiring supplier Declarations of Conformity, monitoring incoming materials, and maintaining manufacturing process controls.

RFI Emissions      FCC Class A, EN55022 Class A, EN61000-3-2, EN61000-3-3, VCCI Class A, C-TICK, CE

**Warning:** In a domestic environment this product may cause radio interference in which case the user may be required to take adequate measures.

Immunity            EN55024

Electrical Safety    EN60950 (TUV), UL 60950 (CUL<sub>US</sub>)



Laser Safety        EN60825

## Translated Safety Statements

---

**Important:** The  indicates that a translation of the safety statement is available in a PDF document titled “Translated Safety Statements” on our web site.

Go to <http://www.alliedtelesis.com/support/software>. Select “Switches” under Product Category and this product under Product Name. You can view this document online or download it onto a local workstation or server.

# Contents

---

<b>Preface</b> .....	11
Safety Symbols Used in this Document.....	12
Where to Find Web-based Guides.....	13
Contacting Allied Telesis.....	14
Online Support.....	14
Email and Telephone Support.....	14
Warranty.....	14
.....	14
Returning Products.....	14
Sales or Corporate Information.....	14
Management Software Updates.....	15
<b>Chapter 1: Overview</b> .....	17
Features.....	18
Front and Back Panels.....	19
Ports.....	20
Twisted Pair Ports.....	20
Uplink Combo Ports.....	20
Eco-friendly Switch.....	21
LEDs.....	22
Power LED.....	22
Port LEDs.....	23
Power Supply.....	24
Ethernet Switching Basics.....	25
MAC Address Table.....	25
Duplex Mode.....	26
Store and Forward.....	26
Back Pressure and Flow Control.....	26
<b>Chapter 2: Installation</b> .....	29
Reviewing Safety Precautions.....	30
Selecting a Site for the Switch.....	32
Cable Specifications.....	33
Twisted Pair Ports.....	33
SFP Ports.....	33
Unpacking the Switch.....	34
Installing the Switch on a Desktop.....	35
Installing the Switch on a Wall.....	36
Installing the Switch in a Rack.....	39
Installing an SFP Transceiver.....	42
Cabling and Powering On the Switch.....	44
Connecting the Twisted Pair Cables.....	44
Connecting the Fiber Optic Cables.....	45
Powering On the Switch.....	46
Starting a Management Session.....	47
<b>Chapter 3: Troubleshooting</b> .....	49

**Appendix A: Technical Specifications** .....51  
Physical Specifications .....51  
Environmental Specifications.....51  
Power Specifications.....51  
Safety and Electromagnetic Emissions Certifications.....52  
Network Protocol and Standards Compatibility.....52  
Connectors and Port Pinouts .....53

**Appendix B: Cleaning Fiber Optic Connectors** .....55  
Using a Cartridge-Type Cleaner .....56  
Using a Swab.....58

# Figures

---

Figure 1. AT-GS950/48 Front and Back Panels .....	19
Figure 2. Eco-friendly Switch .....	21
Figure 3. Power LED .....	22
Figure 4. Port LEDs .....	23
Figure 5. Attaching the Rubber Feet .....	35
Figure 6. Attaching Brackets for Wall Mounting.....	36
Figure 7. Positioning and Drilling Holes for Wall Installation .....	37
Figure 8. Positioning the Switch onto the Wall with Mounting Screws .....	38
Figure 9. Attaching the Rack-Mount Bracket.....	40
Figure 10. Mounting the Switch on the Rack.....	41
Figure 11. Removing the Dust Plug from the SFP Slot .....	42
Figure 12. Inserting the SFP Transceiver.....	43
Figure 13. Connecting the Twisted Pair Data Cables.....	44
Figure 14. Removing the Dust Plug from the SFP.....	45
Figure 15. Connecting the Fiber Optic Cable .....	45
Figure 16. Plugging in the AC Power Cord.....	46
Figure 17. AT-S106 Management Software Main Page.....	47
Figure 18. RJ-45 Connector and Port Pin Layout.....	53
Figure 19. Ferrule in an SC Connector Plug.....	55
Figure 20. Unclean and Clean Ferrule.....	55
Figure 21. Cartridge Cleaner .....	56
Figure 22. Rubbing the Ferrule Tip on the Cleaning Surface .....	56
Figure 23. Lint-Free and Alcohol-Free Swabs .....	58
Figure 24. Cleaning a Recessed Ferrule .....	58





# Tables

---

Table 1. Safety Symbols .....	12
Table 2. Eco-friendly Switch Functions .....	21
Table 3. Power LED Description .....	22
Table 4. 10/100/1000Base-T Port LEDs .....	23
Table 5. Twisted Pair Cabling and Distances .....	33
Table 6. MDI Pin Signals (10Base-T or 100Base-TX) .....	53
Table 7. MDI-X Pin Signals (10Base-T or 100Base-TX) .....	54
Table 8. RJ-45 1000Base-T Connector Pinouts .....	54



# Preface

---

This guide contains instructions on how to install the AT-GS950/48 Gigabit Ethernet Smart switch. This preface contains the following sections:



- “Safety Symbols Used in this Document” on page 12
- “Where to Find Web-based Guides” on page 13
- “Contacting Allied Telesis” on page 14
- “Management Software Updates” on page 15

## Safety Symbols Used in this Document

---

This document uses the safety symbols defined in Table 1.

Table 1. Safety Symbols

Symbol	Meaning	Description
	Caution	Performing or omitting a specific action may result in equipment damage or loss of data.
	Warning	Performing or omitting a specific action may result in electrical shock.

## Where to Find Web-based Guides

---

The installation and user guides for all Allied Telesis products are available in portable document form (PDF) on our web site.

Go to <http://www.alliedtelesis.com/support/software> and enter the model number of your product in the “Search by Product” field. You can view the documents online or download them onto a local workstation or server.

## Contacting Allied Telesis

---

This section provides Allied Telesis contact information for technical support as well as sales and corporate information.

### Online Support

You can request technical support online by accessing the Allied Telesis Knowledge Base: [www.alliedtelesis.com/support/kb.aspx](http://www.alliedtelesis.com/support/kb.aspx). You can use the Knowledge Base to submit questions to our technical support staff and review answers to previously asked questions.

### Email and Telephone Support

For Technical Support via email or telephone, refer to the Support & Services section of the Allied Telesis web site: [www.alliedtelesis.com](http://www.alliedtelesis.com). Select your country from the list displayed on the website. then select the appropriate menu tab.

### Warranty

For the AT-GS950/48 Gigabit Ethernet Smart switch hardware warranty information, refer to the Allied Telesis web site: [www.alliedtelesis.com/support/warranty](http://www.alliedtelesis.com/support/warranty).

### Returning Products

Products for return or repair must first be assigned a return materials authorization (RMA) number. A product sent to Allied Telesis without an RMA number will be returned to the sender at the sender's expense.

To obtain an RMA number, contact the Allied Telesis Technical Support group at our web site: [www.alliedtelesis.com/support/rma](http://www.alliedtelesis.com/support/rma). Select your country from the list displayed on the website. Then select the appropriate menu tab.

### Sales or Corporate Information

You can contact Allied Telesis for sales or corporate information through our web site: [www.alliedtelesis.com](http://www.alliedtelesis.com). To find the contact information for your country, select Contact Us -> Worldwide Contacts.

## Management Software Updates

---

New releases of management software for our managed products are available from either of the following Internet sites:

- ❑ Allied Telesis web site: **[www.alliedtelesis.com](http://www.alliedtelesis.com)**
- ❑ Allied Telesis FTP server: **<ftp://ftp.alliedtelesis.com>**

If you prefer to download new software from the Allied Telesis FTP server from your workstation's command prompt, you will need FTP client software and you must log in to the server. Enter "anonymous" for the user name and your email address for the password.





## Chapter 1

# Overview

---

The AT-GS950/48 Gigabit Ethernet Smart switch is designed to simplify the task of creating or expanding an Ethernet or Fast Ethernet network.

This chapter contains the follows sections:

- ❑ “Features”
- ❑ “Front and Back Panels”
- ❑ “Ports”
- ❑ “Eco-friendly Switch”
- ❑ “LEDs”
- ❑ “Power Supply”
- ❑ “Ethernet Switching Basics”

## Features

---

The features of the AT-GS950/48 Gigabit Ethernet Smart switch include:

- ❑ 44 Auto-Negotiating 10/100/1000Base-T twisted pair ports (1 - 44) with RJ-45 connectors
- ❑ Four uplink combo ports consisting of 100FX/1000SX/LX SFP ports (45 - 48) with four Auto-Negotiating redundant 10/100/1000Base-T twisted pair ports (45R - 48R) with RJ-45 connectors
- ❑ Store and Forward switching supports line rates of
  - 1,480,000 pps (1000 MB/sec)
  - 148,000 pps (100 MB/sec)
  - 14,800 pps (10 MB/sec)
- ❑ Jumbo frames supported up to 10 KB
- ❑ Non-Blocking Full-Wire speed switching on all packet sizes
- ❑ MAC address table capacity of up to 8K addresses with automatic aging
- ❑ IEEE 802, IEEE 802.3u, and IEEE802.3z
- ❑ IEEE 802.3 and IEEE 802.3u compliant
- ❑ IEEE 802.3x supports”
  - Flow Control in full-duplex operation
  - Back Pressure in half-duplex operation
  - Auto MDI/MDI-X on all twisted pair ports (including combo ports)
- ❑ Eco-friendly switch for enabling/disabling port LEDs and for resetting switch
- ❑ Minimizes transmit signal power on each GE port based on the specific cable length to the end point
- ❑ Each port assumes low power mode when link goes down
- ❑ Installation on desktop, mounted on the wall, and mounted in a 19” rack.
- ❑ Smart Fan with fan speed control, device acoustic noise less than 40dB
- ❑ Front panel LEDs for unit and port status
- ❑ Web-based configuration using the AT-S106 Management software

## Front and Back Panels

Figure 1 illustrates the front and back panels of the AT-GS950/48 Gigabit Ethernet Smart switch.

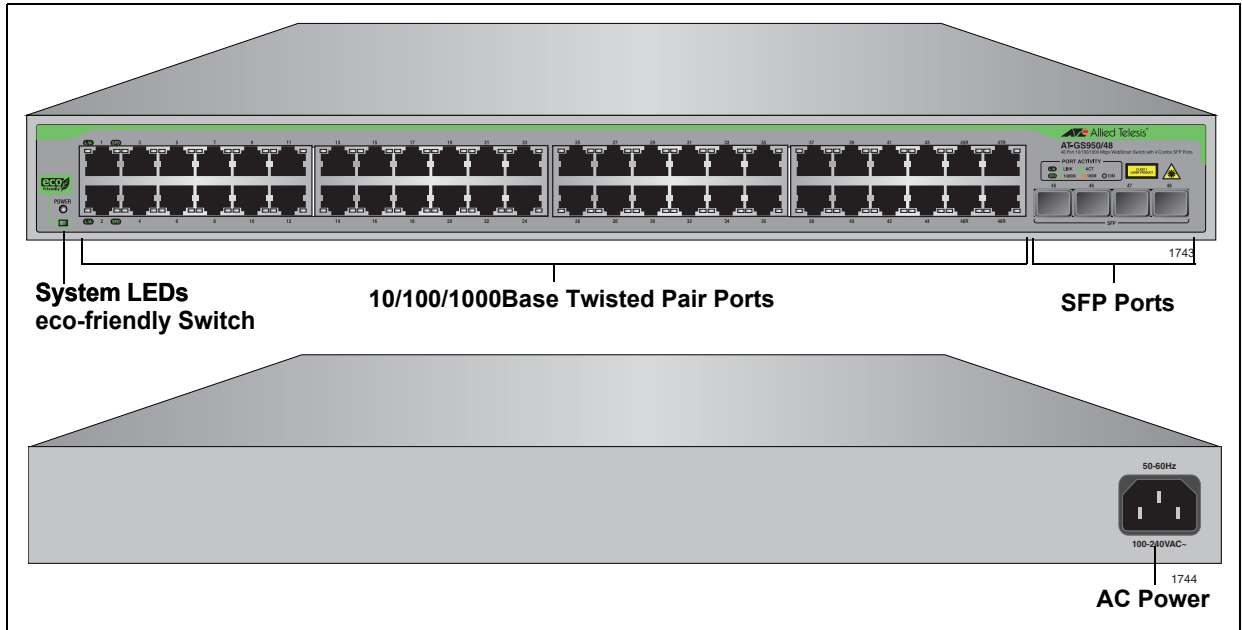

Figure 1. AT-GS950/48 Front and Back Panels

## Ports

---

The AT-GS950/48 Gigabit Ethernet Smart switch features 48 twisted pair ports and four SFP ports. See the following sections for more information:

- “Twisted Pair Ports”
- “Uplink Combo Ports”

### Twisted Pair Ports

The ports on the AT-GS950/48 Gigabit Ethernet Smart switch are capable of 10 megabits per second (Mbps), 100 Mbps, and 1000 Mbps speeds and are 10Base-T, 100Base-TX, and 1000Base-T compliant. In addition, twisted pair ports feature 8-pin RJ-45 connectors.

The ports are IEEE 802.3u Auto-Negotiation compliant. With Auto-Negotiation, the switch automatically matches the highest possible common speed between each switch port and each end node. For example, if an end node is capable of only 10 Mbps, the switch sets the port connected to the end node to 10 Mbps.

Each twisted pair port on the switches can operate in either half- or full-duplex mode. The twisted pair ports are IEEE 802.3u-compliant and Auto-Negotiate the duplex mode setting.

---

#### Note

For the switch to set the duplex mode for each port correctly, the end nodes that you connect to the switch ports must be configured for Auto-Negotiation. Otherwise, a duplex mode mismatch can occur, affecting network performance. For further information, refer to “Duplex Mode”.

---

Each twisted pair port has a maximum operating distance of 100 m (328 feet). For 10 Mbps operation, Category 3 or better 100 ohm shielded or unshielded twisted pair cabling is required. For 100 or 1000 Mbps operation, Category 5 and Enhanced Category 5 (5E) 100 ohm shielded or unshielded twisted pair cabling is required.

The twisted pair ports are auto-MDI. They automatically configure themselves as either MDI or MDI-X, which allows you to use either straight through or crossover twisted pair cables to connect devices to the ports.

### Uplink Combo Ports

The four uplink combo ports (ports 45 through 48) consist of an SFP port and a redundant twisted-pair port. The SFP ports support fiber optic connectivity at 100FX and 1000 SX/LX, while the twisted pair ports support 10/100/1000Base-T. If both ports of a combo pair are connected to the network, traffic is switched through the SFP port and the corresponding twisted pair port acts a redundant port in case of failure.

## Eco-friendly Switch

The eco-friendly switch on the front panel is multifunctional and shown in Figure 2. It may be used to conserve power by turning off the port LEDs, reset the switch, or reset the switch configuration to the factory default settings. The switch functions are described in Table 2.



Figure 2. Eco-friendly Switch

Table 2. Eco-friendly Switch Functions

Action	Results
Momentarily press the switch.	Enable or disable all front panel LEDs with the exception of the POWER LED which remains active at all times.
Hold the switch down for more than 5 seconds, but less than 10 seconds.	Reset the switch.
Hold the switch down for more than 10 seconds.	Reset the switch and reset the configuration to the factory default settings.

## LEDs

---

The AT-GS950/48 Gigabit Ethernet Smart switch provides the following LEDs:

- “Power LED”
- “Port LEDs”

### Power LED

The switch has one power LED, as shown in Figure 3 and described in Table 3.



Figure 3. Power LED

Table 3. Power LED Description

State	Description
Solid Green	The switch is powered up and operating normally.
Off	The switch is not receiving power.

**Port LEDs** Ports 1 through 48 each have two LEDs as shown in Figure 3 and described in Table 4.

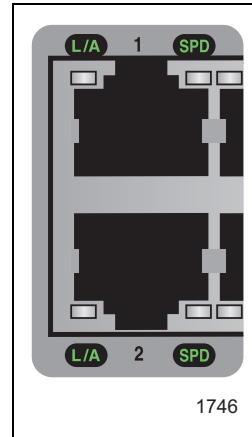

Figure 4. Port LEDs

Table 4. 10/100/1000Base-T Port LEDs

LED	State	Description
L/A	Solid Green	A valid link has been established on the port.
	Blinking Green	The port is transmitting or receiving data.
	Off	No link is established on the port.
SPD	Solid Green	A valid 1000 Mbps link is established between the uplink port and the end node.
	Solid Amber	A valid 100 Mbps link is established between the uplink port and the end node.
	Off	A valid 10 Mbps link is established between the port and the end node when L/A LED is either Solid Green or Blinking Green

## Power Supply

---

The switch has an internal power supply with a single AC power supply socket on the back panel. To power the switch on or off, connect or disconnect the power cord provided with the switch.

---

**Note**

For the power requirements, refer to “Power Specifications”.

---



## Ethernet Switching Basics

---

An Ethernet switch interconnects network devices, such as workstations, printers, routers, and other Ethernet switches, so that they can communicate with each other by sending and receiving Ethernet frames.

### MAC Address Table

Every hardware device on your network has a unique MAC address. This address is assigned to the device by the device's manufacturer. For example, when you install a Network Interface Card (NIC) in a computer so that you can connect it to the network, the NIC already has a MAC address assigned to it by its manufacturer.

The MAC address table in the AT-GS950/48 Gigabit Ethernet Smart switch can store up to 8K MAC addresses. The switch uses the table to store the MAC addresses of the network end nodes connected to the ports, along with the port number on which each address was learned.

A switch learns the MAC addresses of the end nodes by examining the source address of each packet received on a port and adding. It adds the address and port on which the packet was received into the MAC table if the address does not already exist. The result is a table that contains all the MAC addresses of the network devices connected to the switch's ports, and the port number where each address was learned.

When the switch receives a packet, it also examines the destination address and, by referring to its MAC address table, determines the port on which the destination end node is connected. Then it forwards the packet to the appropriate port and on to the end node. This increases network bandwidth by limiting each frame to the appropriate port when the intended end node is located, freeing the other switch ports for receiving and transmitting data.

If the switch receives a packet with a destination address that is not in the MAC address table, it floods the packet to all of the ports on the switch. If the ports have been grouped into virtual LANs, the switch floods the packet only to those ports which belong to the same VLAN as the port on which the packet was received. This prevents packets from being forwarded into inappropriate LAN segments, decreasing network security. When the destination end node responds, the switch adds its MAC address and port number to the table.

If the switch receives a packet with a destination address that is on the same port on which the packet was received, it discards the packet without forwarding it on to any port. Since both the source end node and the destination end node for the packet are located on the same port on the switch, there is no reason for the switch to forward the packet.

## **Duplex Mode**

Duplex mode refers to how an end node receives and transmits data. If an end node can receive or transmit data, but not both simultaneously, it is operating in what is referred to as half-duplex mode. If an end node can both receive and transmit data simultaneously, the end node is operating in full-duplex mode. Naturally, an end node capable of operating in full-duplex can handle data much faster than an end node that can only operate in half-duplex mode.

The twisted pair ports on the AT-GS950/48 Gigabit Ethernet Smart switch can operate in either half-or full-duplex mode. They are IEEE 802.3u-compliant and you can set them to Auto-Negotiation.

For Auto-Negotiation to operate properly on a switch, the end nodes connected to the switch should also use Auto-Negotiation. If an end node does not have this feature and has a fixed duplex mode of full-duplex, the result is a duplex mode mismatch between the end node and a switch port. A port on the Fast Ethernet switch connected to an end node with a fixed duplex mode of full-duplex operates at only half-duplex. This results in the end node using full-duplex and the switch port using half-duplex. This can produce network performance problems. If you encounter this situation, you must configure the port on the end node to use Auto-Negotiation or, if it lacks that feature, to half-duplex.

## **Store and Forward**

The switch uses store and forward as the method for receiving and transmitting frames. When a Ethernet frame is received on a switch port, the switch does not retransmit the frame out the destination port until it has received the entire frame and stored the frame in a port buffer. It then examines the frame to determine if it is a valid frame. Invalid frames, such as fragments or runts, are discarded by the switch. This ensures that only valid frames are transmitted out the switch ports and that damaged frames are not propagated on your network.

## **Back Pressure and Flow Control**

To maintain the orderly movement of data between the end nodes, an Ethernet switch may periodically need to signal an end node to stop sending data. This can occur under several circumstances. For example, if two end nodes are operating at different speeds, the switch, while transferring data between the end nodes, might need to instruct the faster end node to stop transmitting data to allow the slower end node to catch up. An example of this would be when a server operating at 100 Mbps is sending data to a workstation operating at only 10 Mbps.

How a switch signals an end node to stop transmitting data differs depending on the speed and duplex mode of the end node and switch port. A twisted pair port operating at 100 Mbps and half-duplex mode stops an end node from transmitting data by forcing a collision. A collision on an Ethernet network occurs when two end nodes attempt to transmit data using the same data link at the same time. A collision causes end nodes to stop sending data. When the switch needs to stop a 100 Mbps, half-duplex end node from transmitting data, it forces a collision on the

data link, which stops the end node. When the switch is ready to receive data again, the switch stops forcing collisions. This is referred to as back pressure.

A port operating at 100 Mbps and full-duplex mode uses PAUSE frames, as specified in the IEEE 802.3x standard, to stop the transmission of data from an end node. Whenever the switch wants an end node to stop transmitting data, it issues this frame. The frame instructs the end node to cease transmission. The switch continues to issue PAUSE frames until it is ready again to receive data from the end node. This is referred to as flow control.

The AT-GS950/48 Gigabit Ethernet Smart switch supports both transmit (TX) and receive (RX) flow control.



## Chapter 2

# Installation

---

This guide provides the hardware installation instructions for your AT-GS950/48 Gigabit Ethernet Smart switch as well as how to start a management session with the AT-S106 management software. This preface contains the following sections: “Reviewing Safety Precautions” on page 30

- “Selecting a Site for the Switch” on page 32
- “Cable Specifications” on page 33
- “Unpacking the Switch” on page 34
- “Installing the Switch on a Desktop” on page 35
- “Installing the Switch on a Wall” on page 36
- “Installing the Switch in a Rack” on page 39
- “Installing an SFP Transceiver” on page 42
- “Cabling and Powering On the Switch” on page 44
- “Starting a Management Session” on page 47

## Reviewing Safety Precautions

---

Please review the following safety precautions before you begin to install the switch.

---

### Note

The  indicates that a translation of the safety statement is available on the Allied Telesis website.

Go to <http://www.alliedtelesis.com/support/software>. Select “Switches” under Product Category and this product under Product Name. You can view this document online or download it onto a local workstation or server.

---



---

**Warning:** Class 1 Laser product.  L1

---



---

**Warning:** Do not stare into the laser beam.  L2

---



---

**Warning:** To prevent electric shock, do not remove the cover. No user-serviceable parts inside. This unit contains hazardous voltages and should only be opened by a trained and qualified technician. To avoid the possibility of electric shock, disconnect electric power to the product before connecting or disconnecting the LAN cables.  E1

---



---

**Warning:** Do not work on equipment or cables during periods of lightning activity.  E2

---



---

**Warning:** Power cord is used as a disconnection device. To de-energize equipment, disconnect the power cord.  E3

---



---

**Warning:** Class I Equipment. This equipment must be earthed. The power plug must be connected to a properly wired earth ground socket outlet. An improperly wired socket outlet could place hazardous voltages on accessible metal parts.  E4

---

---

Pluggable Equipment. The socket outlet shall be installed near the equipment and shall be easily accessible.  E5

---



---

**Caution:** Air vents must not be blocked and must have free access to the room ambient air for cooling.  E6

---



---

**Warning:** Operating Temperature. This product is designed for a maximum ambient temperature of 40° degrees C. *↪* E7

---

All Countries: Install product in accordance with local and National Electrical Codes. *↪* E8

---



**Warning:** As a safety precaution, install a circuit breaker with a minimum value of 15 Amps between the equipment and the DC power source.

Always connect the wires to the LAN equipment first before you connect the wires to the circuit breaker. Do not work with HOT feeds to avoid the danger of physical injury from electrical shock. Always be sure that the circuit breaker is in the OFF position before connecting the wires to the breaker. *↪* E9

---



**Caution:** The attached mounting brackets must be used to securely mount the device on the wall. *↪* E15

---

Circuit Overloading: Consideration should be given to the connection of the equipment to the supply circuit and the effect that overloading of circuits might have on over current protection and supply wiring. Appropriate consideration of equipment nameplate ratings should be used when addressing this concern. *↪* E21

---



**Warning:** Mounting of the equipment in the rack should be such that a hazardous condition is not created due to uneven mechanical loading. *↪* E25

---

If installed in a closed or multi-unit rack assembly, the operating ambient temperature of the rack environment may be greater than the room ambient temperature. Therefore, consideration should be given to installing the equipment in an environment compatible with the manufacturer's maximum rated ambient temperature (Tmra). *↪* E35

---



**Caution:** Installation of the equipment in a rack should be such that the amount of air flow required for safe operation of the equipment is not compromised. *↪* E36

---



**Warning:** Reliable earthing of rack-mounted equipment should be maintained. Particular attention should be given to supply connections other than direct connections to the branch circuits (e.g., use of power strips). *↪* E37

---

## Selecting a Site for the Switch

---

Observe the following requirements when choosing a site for your switch:

- ❑ If you plan to install the switch in an equipment rack, ensure that the rack is safely secured and that it will not tip over. Devices in a rack should be installed starting at the bottom, with the heavier devices near the bottom of the rack.
- ❑ If you are installing the switch on a table, ensure that the table is level and secure.
- ❑ The power outlet for the switch should be located near the unit and should be easily accessible.
- ❑ The site should provide for easy access to the ports on the front of the switch. This makes it easy for you to connect and disconnect cables, as well as view the switch's LEDs.
- ❑ To allow proper cooling of the switch, air flow around the unit and through its vents on the side and rear should not be restricted.
- ❑ Do not place objects on top of the switch.
- ❑ Do not expose the switch to moisture or water.
- ❑ Ensure that the site is a dust-free environment.
- ❑ Use dedicated power circuits or power conditioners to supply reliable electrical power to the network devices.



## Cable Specifications

---

**Twisted Pair Ports** Table 5 contains the cabling specifications for the twisted pair ports.

Table 5. Twisted Pair Cabling and Distances

Speed	Type of Cable	Maximum Operating Distance
10 Mbps	Category 3 or better 100-ohm shielded or unshielded twisted pair cable	100 m (328 ft)
100 Mbps	Category 5 or Category 5E (Enhanced) 100-ohm shielded or unshielded twisted pair cable	100 m (328 ft)
1000 Mbps	Category 5 and Category 5E (Enhanced) 100-ohm shielded or unshielded twisted pair cable	100 m (328 ft)

---

**Note**

The twisted pair ports on the switch feature auto-MDI when operating at 10, 100 or 1000 Mbps. Each port is individually configured as MDI or MDI-X when connected to an end node. Consequently, you can use either a straight-through or crossover twisted pair cable when connecting any network device to a twisted pair port on the switch.

---

**SFP Ports** Refer to the Allied Telesis data sheet for the cable specifications of the specific SFP transceiver that you are using.

## Unpacking the Switch

---

To unpack the switch, perform the following procedure:

1. Remove all components from the shipping package.

---

**Note**

Store the packaging material in a safe location. You must use the original shipping material if you need to return the unit to Allied Telesis.

---

2. Place the switch on a level, secure surface.
3. Ensure that the following hardware components are included in your switch package. If any item is missing or damaged, contact your Allied Telesis sales representative for assistance.

One AT-GS950/48 Gigabit Ethernet Smart switch and the following:

- Mounting brackets - 2 pieces (1set)
- Rack mounting screws - 8 pieces (for bracket to device)
- Rack Mounting screws - 4 pieces (for bracket to rack)
- Wall mounting anchors - 4 pieces
- Wall mounting screws - 4 pieces
- Rubber feet - 4 pieces
- One power cord

## Installing the Switch on a Desktop

You can place the AT-GS950/48 Gigabit Ethernet Smart switch on a desktop or install it in a 19-inch rack. To install the switch in a rack, refer to “Installing the Switch on a Wall” on page 36.

To place the switch on a desktop, perform the following procedure:

1. Remove all equipment from the package and store the packaging material in a safe place.
2. Turn the switch over and attach the four rubber feet to the bottom of the switch as shown in Figure 5.

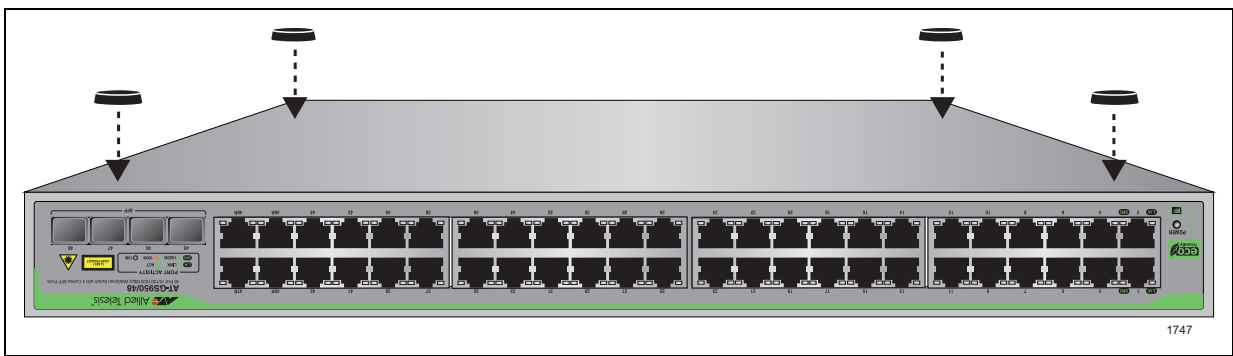

Figure 5. Attaching the Rubber Feet

3. Turn the switch over again and place it on a flat, secure surface (such as a desk or table) leaving ample space around the unit for ventilation.
4. If you plan to install SFP transceiver modules, go to the next step at “Installing an SFP Transceiver” on page 42. Otherwise, your next step is “Cabling and Powering On the Switch” on page 44.

## Installing the Switch on a Wall

---

The AT-GS950/48 Gigabit Ethernet Smart switch can be mounted vertically on a wall using the two mounting brackets, screws, and anchors provided in the accessory kit.

---

### Note

The plastic anchors used for wall mounting the switch are intended for installation in walls made of sheetrock or concrete materials.

---

To wall-mount the switch, perform the following procedure:

1. Place the unit on a level, secure surface.
2. Attach a mounting bracket to one side of the switch using four Phillips head screws that come with the switch, as shown in Figure 6.

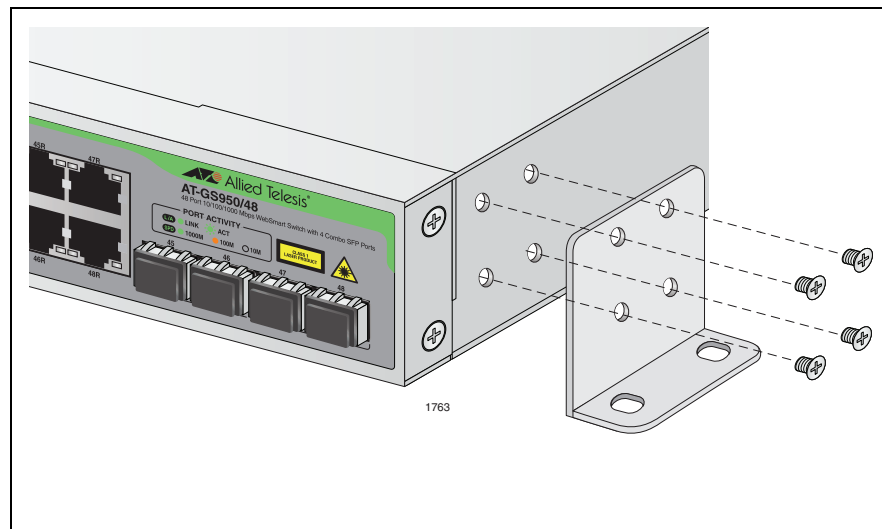

Figure 6. Attaching Brackets for Wall Mounting

3. Install the second mounting bracket on the other side of the switch using the four remaining Phillips head screws.

4. Install four plastic anchors into the wall.

Drill holes in the wall so that they are level with each other and spaced as shown in Figure 7.

Each hole must be 0.635 mm (0.25 in) in diameter.

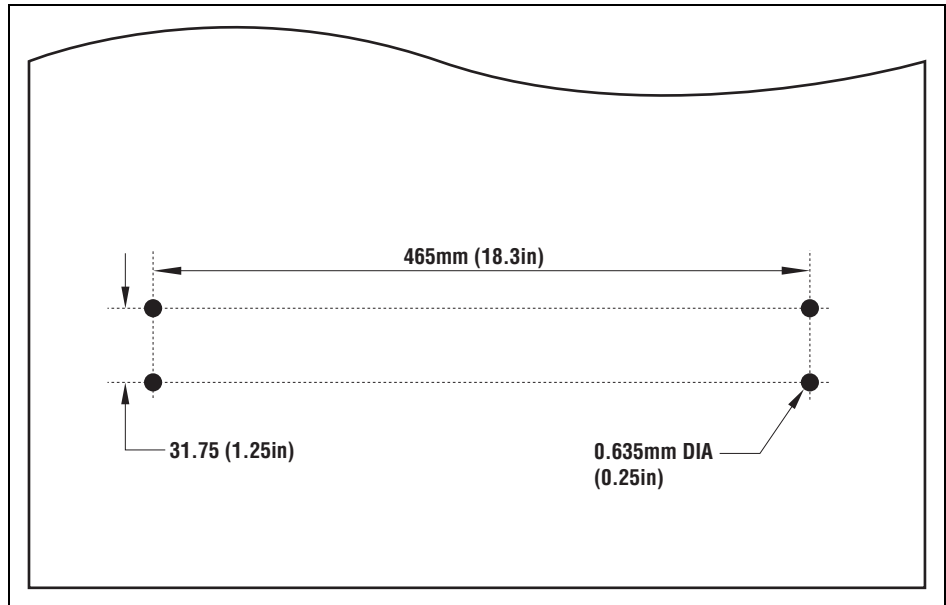

Figure 7. Positioning and Drilling Holes for Wall Installation

5. Position the switch on the wall and fasten with four screws, as illustrated in Figure 8 on page 38.

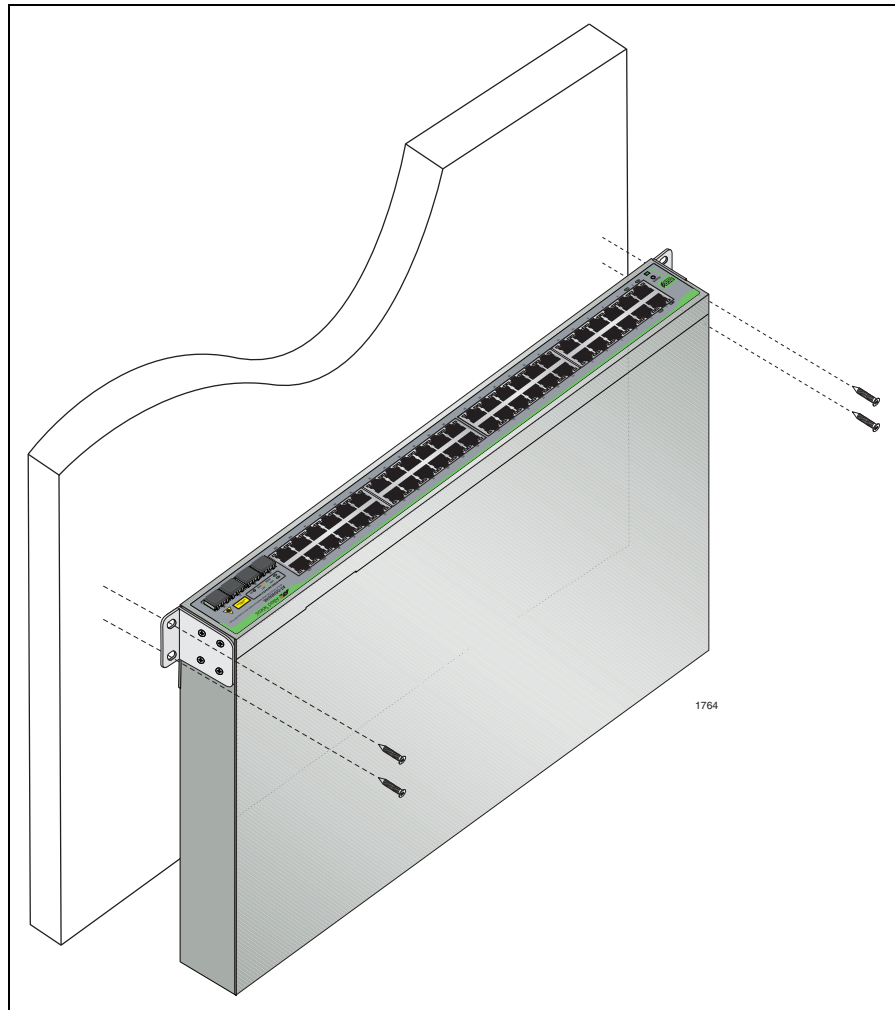

Figure 8. Positioning the Switch onto the Wall with Mounting Screws

6. If you plan to install SFP transceiver modules, go to “Installing an SFP Transceiver” on page 42. Otherwise, your next step is “Cabling and Powering On the Switch” on page 44.

## Installing the Switch in a Rack

---

To install the AT-GS950/48 Gigabit Ethernet Smart switch in a rack, perform the following procedure:

---

**Note**

The rack mount screws are not provided.

---

1. If attached, remove the rubber feet using a flat-head screwdriver as shown in Figure 1.

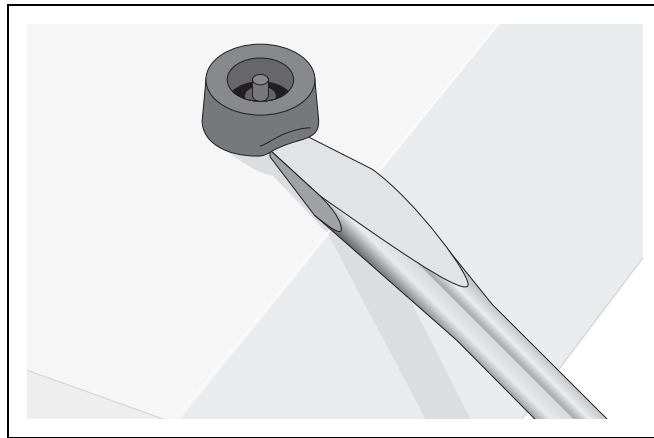

1. Removing Feet from Switch
2. Install a bracket on one side of the switch using a Phillips screwdriver and four of the rack-mount screws included with the switch, as shown in Figure 9

**Caution**

The brackets provided must be used to securely mount the switch on the rack.

---

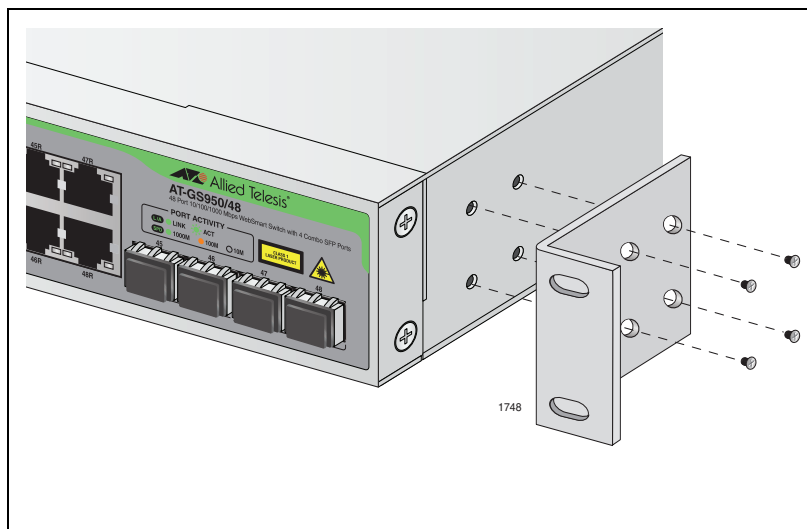

Figure 9. Attaching the Rack-Mount Bracket

3. Repeat step 2 to attach the remaining bracket to the other side of the switch.



4. Mount the switch on a 19-inch rack, as shown in Figure 10.

---

**Note**

The rack mount screws are not provided.

---

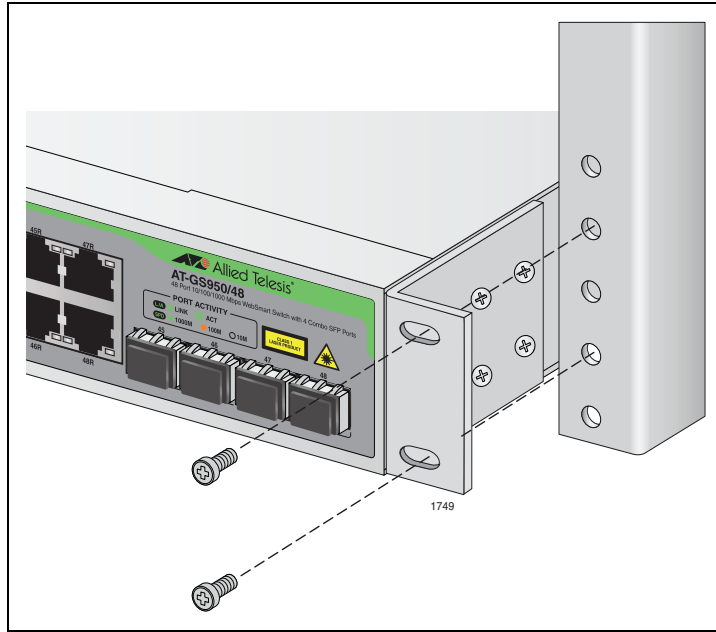

Figure 10. Mounting the Switch on the Rack

5. If you plan to install SFP transceiver modules, go to the next step at “Installing an SFP Transceiver” on page 42. Otherwise, your next step will be “Cabling and Powering On the Switch” on page 44.

## Installing an SFP Transceiver

The AT-GS950/48 Gigabit Ethernet Smart switch has four SFP combo ports. Perform this procedure before “Cabling and Powering On the Switch” on page 44.

To install an SFP transceiver, perform the following procedure:

---

**Note**

The transceiver can be hot-swapped; you do not need to power off the switch to install a transceiver. However, always remove the cables before removing the transceiver.

---

---

**Note**

You must install the transceiver before you connect cables to it.

---

1. Remove the transceiver from its shipping container and store the packaging material in a safe location.
2. Remove the dust plug from the SFP slot, as shown in Figure 11.

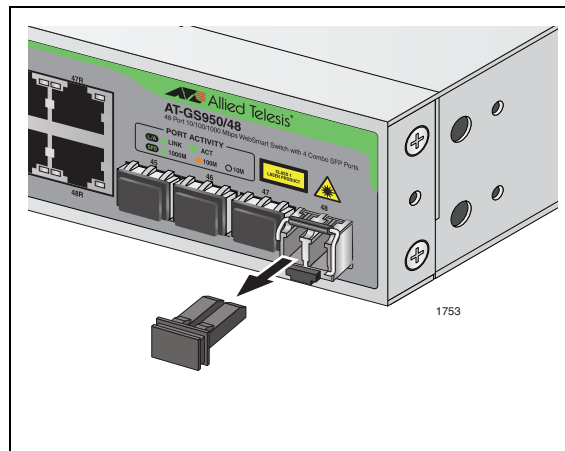

Figure 11. Removing the Dust Plug from the SFP Slot

3. Locate the label on the transceiver and turn it so that the label is on top and the alignment groove is on the bottom.

4. Slide the SFP transceiver into an SFP slot on the switch, as shown in Figure 12.

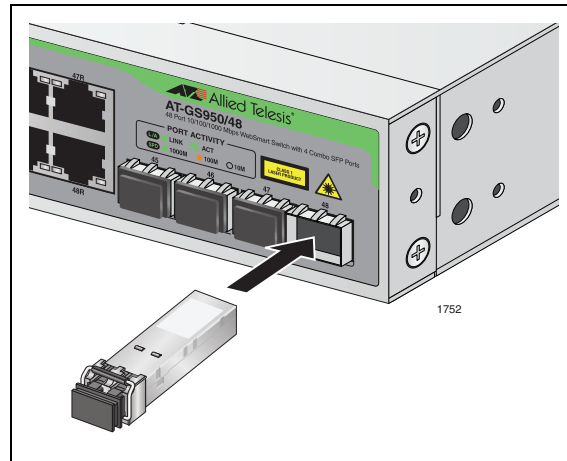

Figure 12. Inserting the SFP Transceiver

5. Repeat steps 2 through 4 if you are installing other SFP transceivers.

---

**Note**

SFP transceivers are dust sensitive. When a fiber optic cable is not installed, or when you store the SFP transceiver, always keep the plug in the optical bores. When you do remove the plug, keep it for future use. Refer to “Cleaning Fiber Optic Connectors” on page 55 if fiber connections require cleaning.

---



---

**Note**

Unnecessary removal and insertion of an SFP transceiver can lead to premature failure.

---

For information about cabling for the SFP transceiver, consult the documentation that was shipped with the SFP module.

## Cabling and Powering On the Switch

### Connecting the Twisted Pair Cables

To connect the twisted cables to the RJ-45 ports on the AT-GS950/48 Gigabit Ethernet Smart switch, perform the following procedure:

#### Note

If you plan to configure a redundant data path, make sure that the Spanning Tree feature is enabled via the AT-S106 Management Software before connecting the ethernet cables for your secondary network connections.

1. Plug the twisted pair data cables to the RJ-45 ports on the switch, as shown in Figure 13.

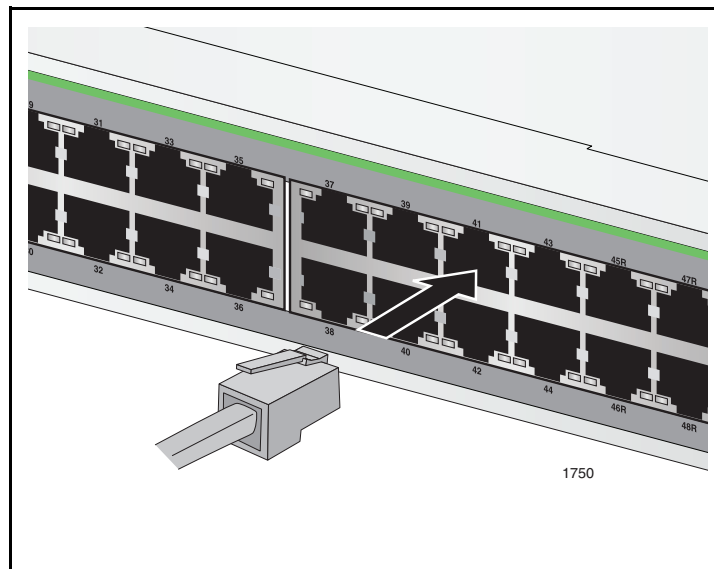

Figure 13. Connecting the Twisted Pair Data Cables

When you connect a twisted pair cable to a port, observe the following guidelines:

- An RJ-45 connector should fit snugly into the port on the switch. The tab on the connector should lock the connector into place.
  - The ports on the switch are auto-MDI/MDI-X. You can use either a straight-through or crossover twisted pair cable to connect any type of network device to a port on the switch.
  - The network should not contain data loops, which can adversely affect network performance. A data loop exists when two or more network devices can communicate with each other over more than one data path.
2. Connect the other end of the twisted pair cable to a port in the end node.

## Connecting the Fiber Optic Cables

To connect a fiber optic cable to an SFP transceiver installed in the AT-GS950/48 Gigabit Ethernet Smart switch, perform the following procedure:

---

### Note

If you plan to configure a redundant data path, make sure that the Spanning Tree feature is enabled via the AT-S106 Management Software before connecting the ethernet cables for your secondary network connections.

---

1. Remove the dust plug from the SFP transceiver, as shown in Figure 14.

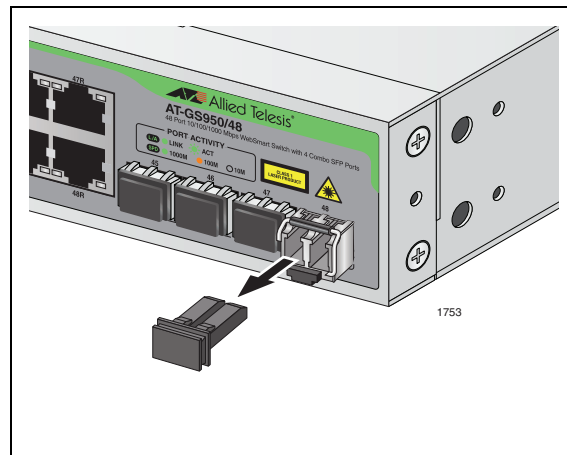

Figure 14. Removing the Dust Plug from the SFP

2. Connect the fiber optic cable to the SFP port, as shown in Figure 15.

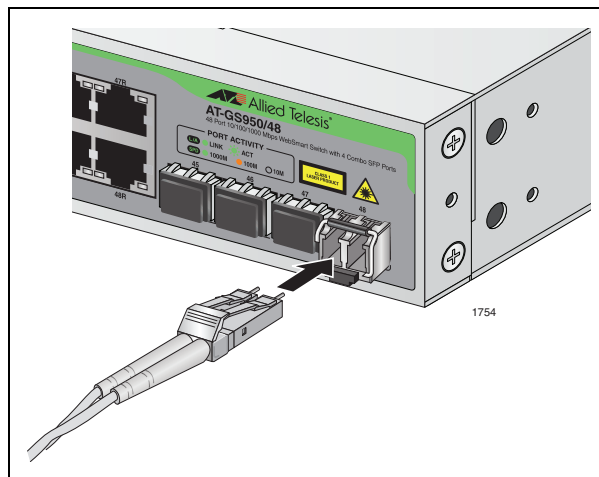

Figure 15. Connecting the Fiber Optic Cable

---

**Note**

If you plan to configure a redundant data path, insure that the Spanning Tree feature is enabled via the AT-S106 Management Software before connecting the ethernet cables.

---

**Powering On the Switch**

To power on the switch, perform the following procedure:

1. Plug the power cord into the AC power connector on the back of the switch, as shown in Figure 16.

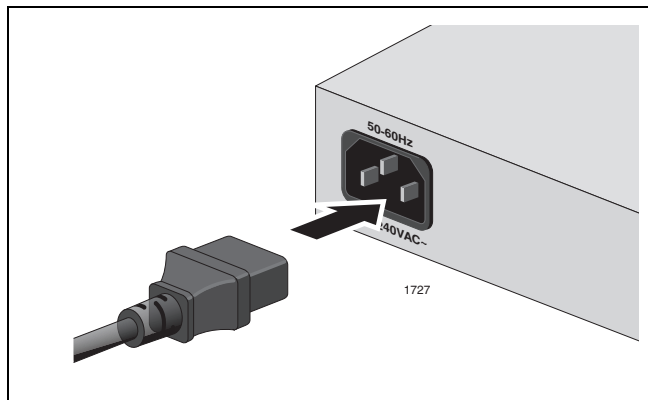

Figure 16. Plugging in the AC Power Cord

2. Plug the other end of the power cord into a wall outlet.



**Warning:** Power cord is used as a disconnection device. To de-energize equipment, disconnect the power cord. ⚡ E3

---

Pluggable Equipment. The socket outlet shall be installed near the equipment and shall be easily accessible. ⚡ E5

---

3. Verify that the POWER LED is green. If the LED is OFF, refer to Chapter 3, “Troubleshooting” on page 49.

---

**Note**

The switch is now powered on and ready for network operations. To start a local management session on the switch, refer to “Starting a Management Session” on page 47. For more information about starting a remote management session, see the *AT-S106 Management Software User’s Guide*.

---

## Starting a Management Session

To start a management session on an AT-GS950/48 Gigabit Ethernet Smart switch, perform the following procedure:

1. In a web browser address box, enter the following IP address:

192.168.1.1

The main page for the AT-S106 management software main page is shown in Figure 17.

**Allied Telesis AT-GS950/48 Smart Switch**

- Switch Info.
- Front Panel
- System
- Physical Interface
- Bridge
- SNMP
- Security
- Statistics Chart
- Tools
- Save Configuration to Flash

### Switch Information

**System Up For:** 0 day(s), 0 hr(s), 1 min(s), 4 sec(s)  
**Runtime Image:** AT-S106 V1.0.0 [0.1.0.05] / Oct 29 2009 17:00:49  
**Boot Loader:** 1.0.0.10 / Oct 30 2009 10:57:20

### Hardware Information

- Version: .
- DRAM Size: 64 MB
- Flash Size: 8 MB

### Administration Information

- System Name:
- System Location:
- System Contact:

### System MAC Address, IP Address, Subnet Mask and Gateway

- MAC Address: 00:A0:D2:00:00:01
- IP Address: 192.168.1.1
- Subnet Mask: 255.255.255.0
- Default Gateway: 0.0.0.0

### Automatic Network Features

- DHCP Client Mode: Disabled

Figure 17. AT-S106 Management Software Main Page

2. Click **OK**.

Because the switch initially has no login or password protection, follow the instructions in the *AT-S106 Management Software User's Guide* to change the IP address and add administrative users.





## Chapter 3

# Troubleshooting

This chapter contains information on how to troubleshoot the switch in the event that a problem occurs.

---

**Note**

If you need further assistance, please contact Allied Telesis Technical Support. Refer to “Contacting Allied Telesis” on page 14.

---

Check the POWER LED on the front of the switch. If the LED is off, indicating that the unit is not receiving power, do the following:

- Ensure that the power cord is securely connected to the power source and to the AC connector on the back panel of the switch.
- Verify that the power outlet has power by connecting another device to it.
- Try connecting the unit to another power source.
- Try using a different power cord.
- Verify that the voltage from the power source is within the required levels for your region.

Verify that the LINK/ACT LED for each connected port is ON. If a LINK/ACT LED is OFF, do the following:

- Verify that the end node connected to the port is powered on and is operating properly.
- Verify that the twisted pair cable is securely connected to the port on the switch and to the port on the end node.
- Ensure that the twisted pair cable does not exceed 100 meters (328 feet).
- Verify that you are using the appropriate category of twisted pair cable:
  - Category 3 or better for 10 Mbps operation
  - Category 5 and Category 5E for 100 and 1000 Mbps operation.

---

**Note**

A 1000Base connection may require five to ten seconds to establish a link.

---



## Appendix A

# Technical Specifications

---

## Physical Specifications

---

Dimensions (W x D x H):	440 mm x 257 mm x 43.2 mm (17.32 in x 10.12 in x 1.70 in)
Weight:	4.047 kg (8.92 lbs)

## Environmental Specifications

---

Operating Temperature:	0° C to 40° C (32° F to 104° F)
Storage Temperature:	-25° C to 70° C (-13° F to 158° F)
Operating Humidity:	5% to 90% non-condensing
Storage Humidity:	5% to 95% non-condensing
Operating Altitude Range:	Up to 3,000 m (9,843 Feet)

## Power Specifications

---

Input Supply Voltage:	100 - 240 VAC, 50/60 Hz
Power Consumption:	< 54 Watts

## Safety and Electromagnetic Emissions Certifications

---

EMI/RFI:	FCC Class A, EN55022 Class A, CISPR Class A
Immunity:	EN55024
Electrical Safety:	EN60950-1 (TUV), UL60950-1 (cUL <sub>us</sub> )
Quality and Reliability:	MTBF > 260,000 Hours
Safety Agency Approvals:	cUL <sub>us</sub> , TUV, C-TICK, CE

## Network Protocol and Standards Compatibility

---

- IEEE802.3 CSMA/CD
- IEEE802.3u 100BaseTx
- IEEE802.3z 1000BaseSX
- IEEE802.3ab 1000BaseT
- IEEE802.3x flow control
- IEEE 802.1p QoS
- IEEE 802.1Q
- IEEE 802.1D STP
- IEEE 802.1w RSTP
- IEEE 802.3ad LACP
- IEEE 802.1X MAC-Based Authentication

## Connectors and Port Pinouts

---

This section lists the connectors and connector pinouts for the AT-GS950/48 Gigabit Ethernet Smart switch and its components.

Figure 18 illustrates the pin layout for an RJ-45 connector and port.

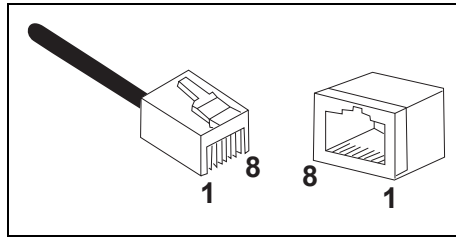

Figure 18. RJ-45 Connector and Port Pin Layout

Table 6 lists the RJ-45 pin signals when a twisted pair port is operating in the MDI configuration.

Table 6. MDI Pin Signals (10Base-T or 100Base-TX)

Pin	Signal
1	TX+
2	TX-
3	RX+
6	RX-

Table 7 lists the RJ-45 port pin signals when a twisted pair port is operating in the MDI-X configuration.

Table 7. MDI-X Pin Signals (10Base-T or 100Base-TX)

Pin	Signal
1	RX+
2	RX-
3	TX+
6	TX-

Table 8 lists the RJ-45 connector pins and their signals when a 1000Base-T port is operating at 1000 Mbps.

Table 8. RJ-45 1000Base-T Connector Pinouts

Pin	Pair	Signal
1	1	TX and RX+
2	1	TX and RX-
3	2	TX and RX+
4	3	TX and RX+
5	3	TX and RX-
6	2	TX and RX-
7	4	TX and RX+
8	4	TX and RX-

## Appendix B

# Cleaning Fiber Optic Connectors

---

The fiber optic connector consists of a fiber optic plug and its adapter. The end of the fiber optic cable is held in the core of the ferrule in the plug. Light signals are transmitted through the core of the fiber. Even minor smudges or dirt on the end face of the fiber, completely invisible to the naked eye, can disrupt light transmission and lead to failure of the component or of the entire system. Therefore, it is of utmost importance to clean all fiber optic connectors before use.

Figure 19 shows the ferrule in an SC connector.

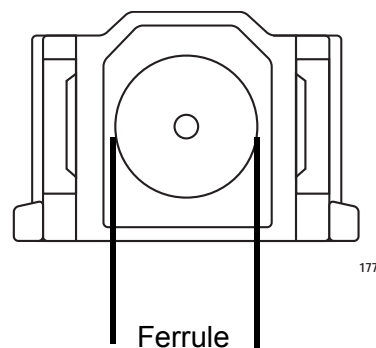

Figure 19. Ferrule in an SC Connector Plug

Figure 20 shows part of the end face of an unclean and clean ferrule.

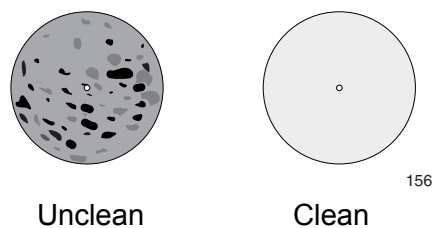

Figure 20. Unclean and Clean Ferrule

This appendix provides the following procedures

- ❑ “Using a Cartridge-Type Cleaner” on page 56
- ❑ “Using a Swab” on page 58

## Using a Cartridge-Type Cleaner

---

Fiber optic cartridge cleaners are available from many vendors and are typically called “cartridge cleaners,” as shown in Figure 21.



Figure 21. Cartridge Cleaner

---

**Note**

Do not use compressed air or aerosol air to clean a fiber optic connector.

---

To clean a fiber optic connector using a cartridge cleaner, perform the following procedure.

3. With one hand, hold the cartridge cleaner and push the lever on the cleaning cartridge in the direction of the arrow to expose the cleaning surface, as shown in Figure 22.
4. Place the ferrule tip on the exposed cleaning surface and rub the ferrule in a downward direction, as shown in Figure 22.

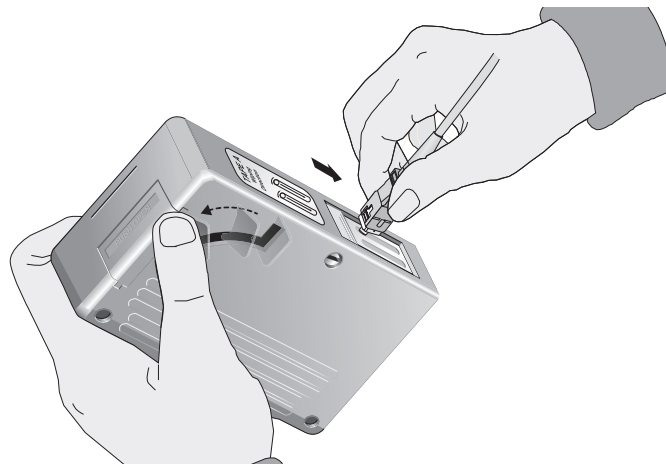

Figure 22. Rubbing the Ferrule Tip on the Cleaning Surface



---

**Note**

Rub the ferrule tip on the cleaning surface in one direction only.

---

5. When you reach the end of the cleaning surface, pick up the ferrule tip, rotate and place it at the top and rub downwards at least 2 times.



---

**Caution**

Failing to pick up the ferrule tip when you reach the bottom of the cleaning surface can result in static electricity that can damage the fiber optic cable.

---

6. If desired, repeat steps 3 and 4.
7. If a fiber inspection scope is available, use the scope to inspect the ferrule end face to make sure that it is clean.
8. Reconnect the cable to the port or protect the ferrule tip with a dust cap.

---

**Note**

Always keep a dust cap on a fiber optic cable when it is not in use.

---



---

**Note**

Do not touch the end face of the ferrule in the connector.

---



---

**Warning:** Do not stare into the laser beam. ⚠ 2

---



---

**Warning:** Do not look directly at the fiber optic cable ends or inspect the cable ends with an optical lens. ⚠ 31

---

## Using a Swab

---

Specially treated swabs (stick cleaners) are available for cleaning inside connector adapters or hard-to-reach ferrule tips. These swabs, often referred to as “lint free” or “alcohol free” swabs, are available from many vendors, as shown in Figure 23. Stick cleaners are available in both 2.5 mm and 1.25 mm sizes for use on SC and MU connectors respectively.

---

**Note**

NEVER use a household cotton swab and/or alcohol to clean a fiber optic connector. This may leave a residue on the ferrule tip.

---

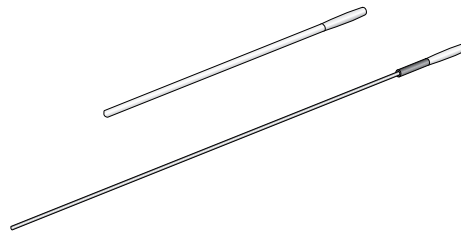

Figure 23. Lint-Free and Alcohol-Free Swabs

---

**Note**

Do not use compressed air or aerosol air to clean a fiber optic connector.

---

To clean a recessed ferrule using a swab, perform the following procedure.

1. Insert the swab into the adapter as shown in Figure 22 and rub the ferrule tip with the swab.

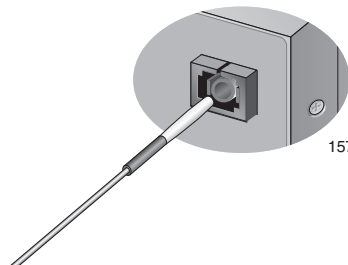

Figure 24. Cleaning a Recessed Ferrule

2. If desired, repeat step 1.

3. If a fiber inspection scope is available, use the scope to inspect the connector to make sure that it is clean and to check for scratches, pits, or other problems that may affect performance.

---

**Note**

Always keep a dust cap on a fiber optic cable when it is not in use.

---

---

**Note**

Do not touch the end face of the ferrule in the connector.

---



**Warning:** Do not stare into the laser beam. *2*

---



**Warning:** Do not look directly at the fiber optic cable ends or inspect the cable ends with an optical lens. *31*

---

